



20¹⁶/₁₇ / POL-EKO-APARATURA products



POL-EKO-APARATURA has been present in the Polish market for 26 years.

Highest quality equipment and service we provide ensures your satisfaction. Our wide range of products and professional solutions will suit the most demanding customers.

We remain open to assist in choosing the right product for your needs, as well as to provide you with customized solutions.

We are your partner in lab analysis and technological processes.

Thank you for your confidence.

POL-EKO-APARATURA team.



\ <i>Table of contents</i>	3
\ <i>Development history</i>	4
\ THERMOSTATIC EQUIPMENT	7
\ <i>Cooled incubators [ST]</i>	11
\ <i>Laboratory refrigerators</i>	21
\ <i>Laboratory freezers</i>	29
\ <i>Ultra-low freezers</i>	35
\ <i>Laboratory incubators</i>	43
\ <i>Cooled incubators [IL]</i>	45
\ <i>Peltier-cooled incubators</i>	47
\ <i>Drying ovens</i>	51
\ <i>Drying ovens with nitrogen blow</i>	53
\ <i>SIMPLE drying oven</i>	54
\ <i>Laboratory sterilizers</i>	57
\ <i>Climatic chambers and climatic chambers with phytotron system</i>	59
\ OPTIONS AND ACCESORIES	69
\ <i>Options and accessories</i>	70
\ <i>Parameters</i>	82
\ OTHER LABORATORY EQUIPMENT	83
\ <i>RT 2014 data logger</i>	85
\ <i>Thermostatic boxes</i>	88
\ <i>Colony counter</i>	89
\ <i>Laboratory shakers</i>	90
\ <i>Stationary samplers</i>	92
\ LABORATORY FURNITURE, FUME HOODS	93
\ <i>Compact Lab furniture</i>	94
\ <i>Fume hoods</i>	101

Development history





Trust and confidence in our products made us receive a number of valuable awards.

March 2003

Eurolab Trade Fairs
Award
EcaFlow 150 GLP



March 2003

Eurolab Trade Fairs
Award
CyberScan 5500



March 2004

Eurolab Trade Fairs
Award
BOD OxiDirect



March 2004

Eurolab Trade Fairs
Award
Monitoring station
PP 2002M



March 2005

Eurolab Trade Fairs
Award
CyberScan 6500



May 2008

City Mayor of Wodzisław Śląski
awards POL-EKO-APARATURA
for involvement in cooperation
between Polish and Czech
enterprises and
municipalities



March 2009

Eurolab Trade Fairs
Award
Orion STAR PLUS



March 2009

POL-EKO-APARATURA
receives an award from
Local chamber of commerce:
„Friendly to the environment”



May 2009

POL-EKO-APARATURA
chosen the 2008
„Local Leader of Enterprise”



March 2010

Eurolab Trade Fairs
Award
Cooled incubator
ILW 115 TOP+



March 2010

Eurolab Trade Fairs
Award
stationary sampler
PP 2002



October 2014

1st Award in the contest:
“Employer - organizer of safe workplace”
by Regional Labour Inspectorate



March 2015

Acknowledgement from
the Minister of Economy





01

**Thermostatic
equipment**

Thermostatic equipment

\ Cooled incubators (ST), laboratory refrigerators	9
\ POL-EKO measurement laboratory	10
\ Cooled incubators (ST)	11
\ PREMIUM TOP+ version	14
\ single chamber	16
\ double chamber	17
\ with photoperiodic system	19
\ with phytotron system	20
\ Laboratory refrigerators	21
\ BASIC version, COMFORT version, PREMIUM version	22
\ TOP+ version	24
\ single chamber	26
\ double chamber	27
\ Laboratory freezers	29
\ Ultra-low freezers	35
\ Drying ovens, incubators, cooled incubators	39
\ STD version	40
\ TOP+ version	41
\ Laboratory incubators (IL)	43
\ Cooled incubators	45
\ Peltier-cooled incubators	47
\ with photoperiodic system	49
\ with phytotron system	50
\ Laboratory drying ovens	51
\ drying ovens	52
\ with nitrogen blow	53
\ simple	54
\ pass-through	56
\ Laboratory sterilizers	57
\ Climatic chambers	59
\ Climatic chambers with phytotron system	62
\ Climatic chambers KKS	64
\ Software	68

Cooled incubators (ST) and Laboratory refrigerators

Material of construction

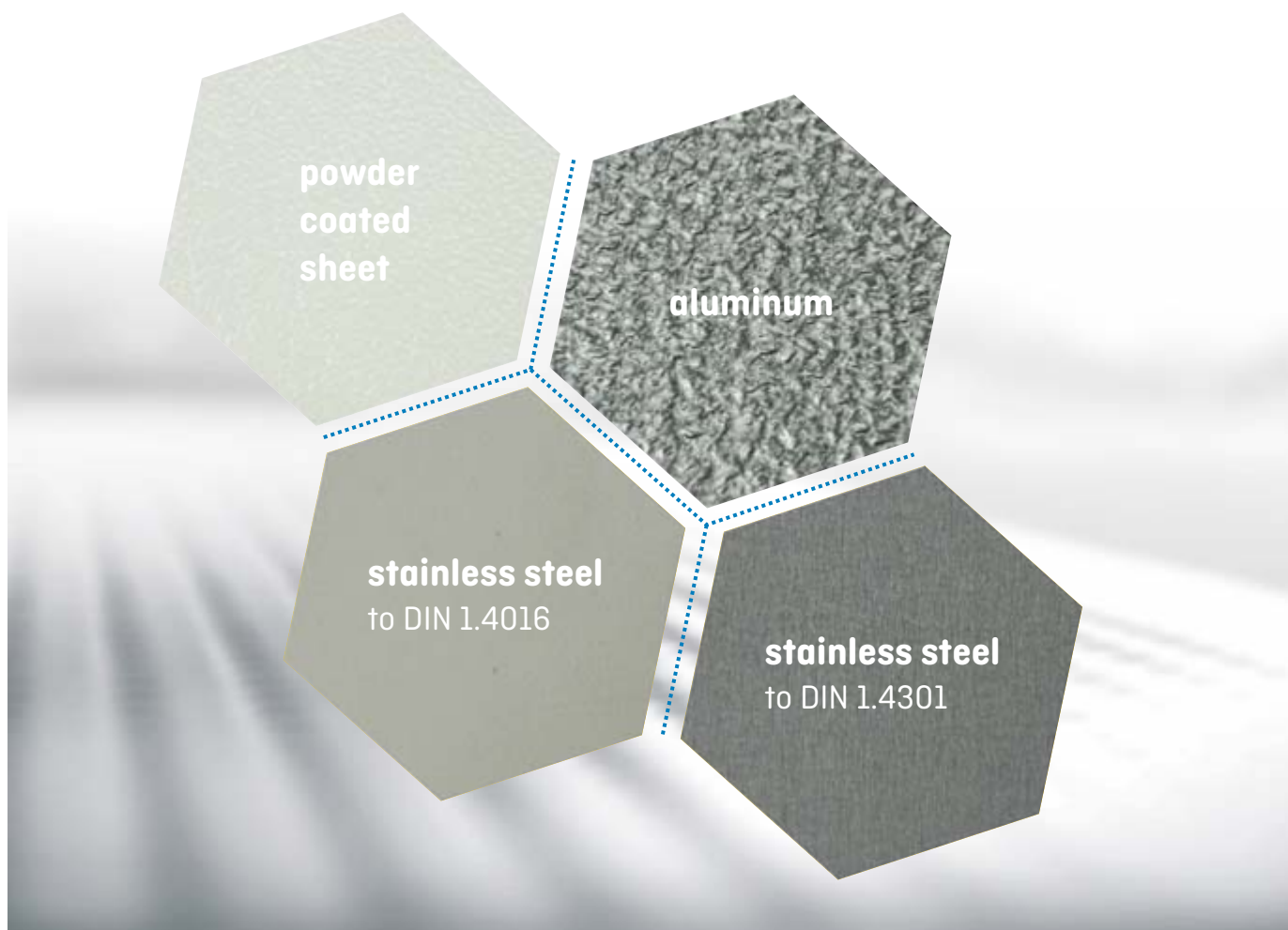

There is wide selection of models depending on capacity, basic or more advanced controllers and material of construction. The following versions are available:

	interior	exterior	temperature protection	controller
BASIC	aluminum	powder coated sheet	class 1.0	basic
COMFORT	stainless steel to DIN 1.4016	powder coated sheet	class 1.0	basic
COMFORT/S	stainless steel to DIN 1.4016	polished stainless steel	class 1.0	basic
PREMIUM	stainless steel to DIN 1.4301	powder coated sheet	class 2.0	basic
PREMIUM/S	stainless steel to DIN 1.4301	polished stainless steel	class 2.0	basic
PREMIUM TOP+	stainless steel to DIN 1.4301	powder coated sheet	class 3.3	TOP+
PREMIUM/S TOP+	stainless steel to DIN 1.4301	polished stainless steel	class 3.3	TOP+

POL-EKO Measurement Laboratory is Accredited by the Polish Centre for Accreditation (a member of ILAC) and provides accredited services



AP 115



Short lead time at no extra charge.

We provide accredited services in calibration range of:

- thermostatic and climatic chambers
- water baths
- thermoreactors
- lab furnaces
- chambers for steam sterilization (autoclaves)

Calibration of **thermostatic and climatic chambers**, method temperature range: -25...+200°C

Calibration of **climatic chambers** in the range of relative humidity, method temperature range: +15...+40°C for humidity 40...98%

Calibration of **water baths and thermoreactors**, method temperature range: -25...+200°C

Calibration of **lab furnaces**, method temperature range: +100...+1000°C

Calibration of **chambers for steam sterilization (autoclaves)**, method temperature range: +60...+140°C

After calibration the customer receives the calibration certificate which features: average value in each point, load effect (optionally), measurement uncertainty and temperature/humidity stability.

Within accreditation we also calibrate:

- electric and electronic thermometers
- temperature data loggers
- thermohygrometers

Calibration of **electric and electronic thermometers and data loggers** with an external sensor, method temperature range: -25...+1000°C

Calibration of **electric and electronic thermometers and data loggers** with an internal sensor, method temperature range: 0...+140°C

Calibration of **thermohygrometer**, method temperature range: +10...+60°C, method relative humidity range: 30...98%



After calibration the customer receives the calibration certificate which features: average value of temperature/ humidity, temperature (variation) correction and measurement uncertainty.

Cooled incubators (ST)

Application

- BOD determination
- microbiological research
- plant growing and microorganisms breeding at specified temperature
- storage of liquids and samples for physicochemical analysis



Cooled incubators (ST) can provide a stable temperature between $+3...+70^{\circ}\text{C}$ regardless of ambient conditions.

Calibration



All thermostatic equipment manufactured by POL-EKO-APARATURA can be provided with Calibration Certificate issued by accredited Measurement Laboratory. Detailed information on accreditation of POL-EKO Laboratorium Pomiarowe is available on website: www.polekolab.pl.



The **BASIC, COMFORT, PREMIUM** models are equipped with a PID microprocessor controller with an LCD graphic display and illuminated touch buttons.

Controller advantages

- six segment temperature-time profile
- loop function up to 99 times or endless
- 3 user programs memory
- adjustable start delay feature (from 1 min to 99:59 h)
- adjustable hold at set point time for temperature and lighting (for ST/FOT) from 1 min to 31 days / 1 min to 99:59 h or continuous operating
- recording of min, average and max temperature value for each segment
- overview of set and current parameters while operating
- audible and visual temperature alarm
- operating with temperature priority mode
- defrosting function
- temperature sensor fail alarm
- power failure control system (program continued after restoring power)
- digital timer
- real time clock
- auto-diagnostic function
- internal memory to store up to 2046 data records
- forced air convection with optional fan speed control 50-100%
- automatic fan shut-down after completing the program

Detailed description of parameters on page 82.

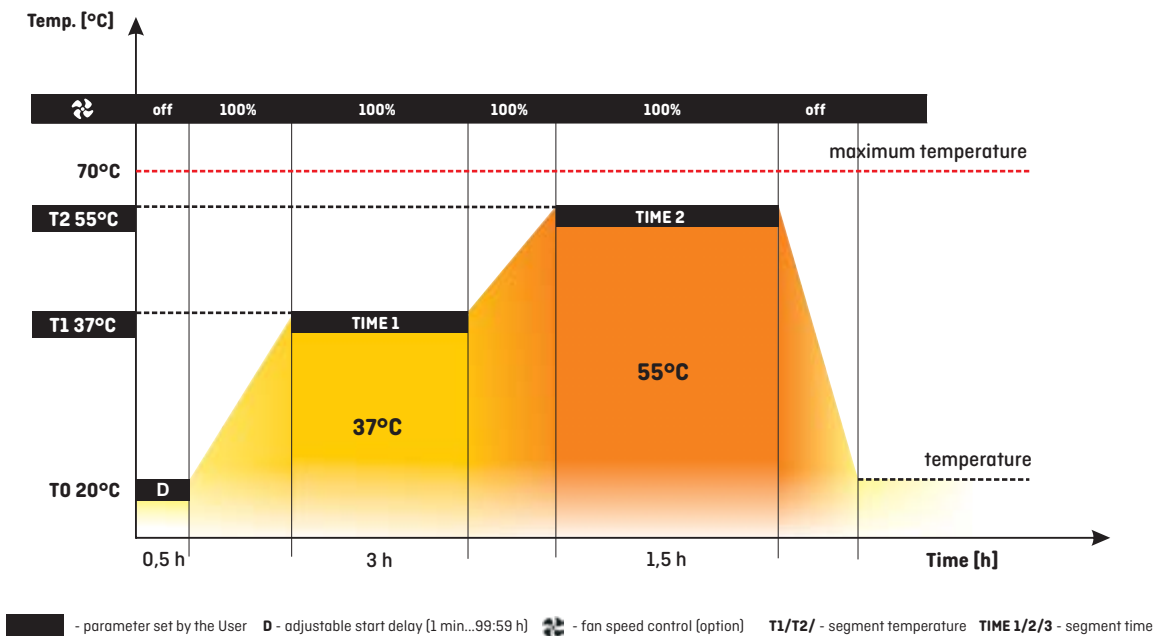

Control panel

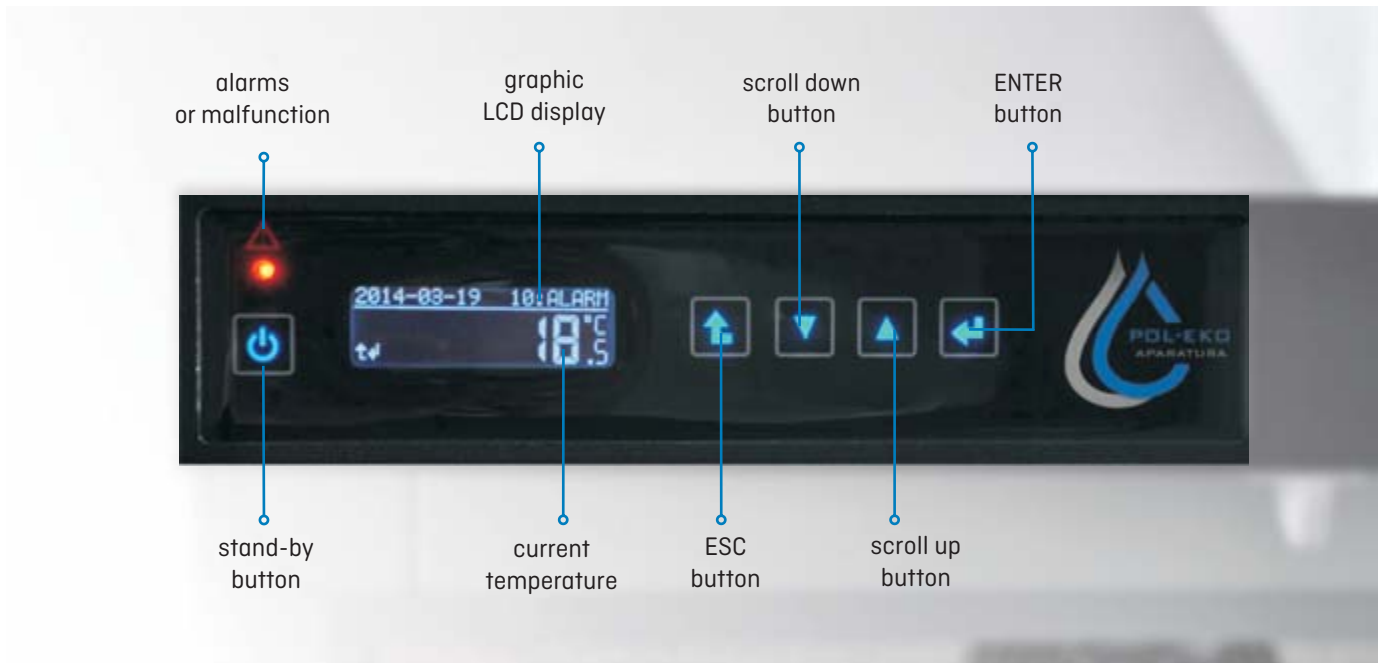

Standard features

- temperature range +3...+40°C
- quality control protocol (at +37°C)
- English instruction manual
- available menu languages: Czech, English, Estonian, French, German, Italian, Latvian, Polish, Portuguese, Russian, Spanish
- temperature protection 1.0 class for BASIC and COMFORT models and 2.0 for PREMIUM models to DIN 12880
- open door alarm
- wheels in standard for models ST 1200 and 1450

RS 232 and USB ports for data transfer

internal LED light

access port: Ø30 mm

door lock

wire shelves for BASIC and stainless steel wire shelves for COMFORT and PREMIUM models

solid door



PREMIUM TOP+ version

All the units in TOP+ version are equipped with PID microprocessor controller with a large (5,7") full colour touch screen, intuitive menu and user friendly software. They can be connected to Ethernet network for remote control from any computer, being one of the greatest advantages.

Controller advantages

- multi-segment temperature-time profile (up to 100)
- loop function up to 99 times or endless
- adjustable start delay feature (from 1 min to 99:59 h or date/time)
- access control via login
- 7-days programming
- adjustable hold at set point time for temperature and lighting (for ST/FIT) from 1 min to 999:59 h, or continuous operating
- adjustable ramps
- overview of set and current parameters while operating
- recording of min, average and max temperature value for each segment
- Administrator function to manage User accounts
- possibility of temperature calibration by the User
- audible and visual temperature alarm
- operating in temperature or time priority mode
- defrosting function
- temperature sensor fail alarm
- power failure control system (program continued after restoring power)
- digital timer
- real-time clock
- auto-diagnostic function
- forced air convection with fan speed control (50-100%)
- automatic fan shut-down after completing the program

Detailed description of parameters on page 82.

GLP supporting functions

- password protected settings
- 20 user programs memory
- internal memory to store up to 4100 data records for each User, possibility to overview the values on the display or a PC computer in tabular or graphic form
- USB port to allow direct data recording or transfer into a flash drive
- events registry

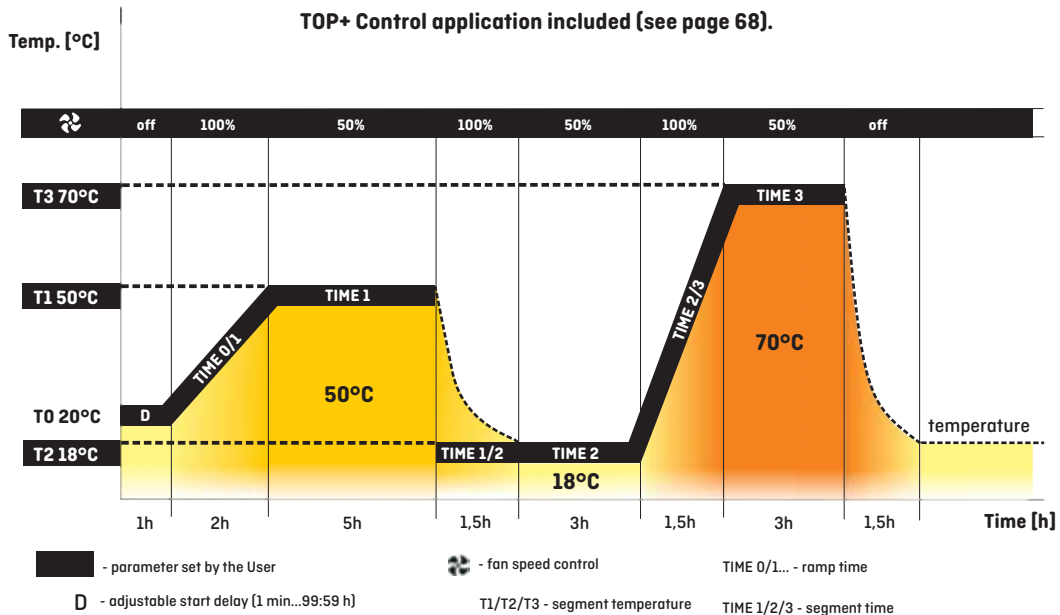

Control panel

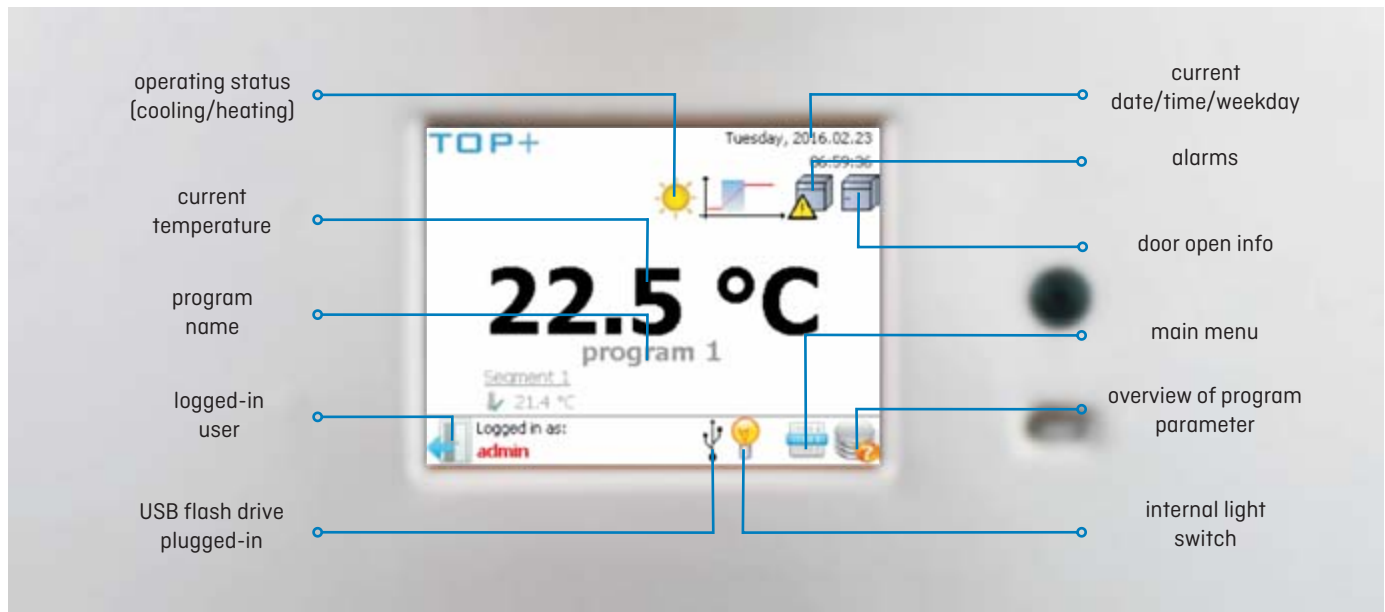

Standard features

- temperature range +3...+70°C
- Ethernet cable
- TOP+ Control software
- quality control protocol (at +37°C)
- English instruction manual
- available menu languages: English, Estonian, French, German, Hungarian, Italian, Latvian, Polish, Portuguese, Romanian, Russian, Spanish
- temperature protection 3.3 class to DIN 12880
- open door alarm
- wheels in standard for models ST 1200 and 1450

door lock

USB port to allow direct recording and data transfer onto a flash drive

RS 232 interface and LAN port

internal LED light

access port: Ø30 mm

wire stainless steel shelves

solid door



Cooled incubators (ST)

ST

		ST 1	ST 2	ST 3	ST 4	ST 5	ST 6	ST 500	ST 700	ST 1200	ST 1450
Parameter											
air convection		forced									
chamber capacity [l]		70	150	200	250	300	400	500	625	1365	1460
working capacity [l]		55	122	163	203	243	324	386	450	1229	1307
door type		solid / glass or double ¹ (option)									
temperature range [°C]		+3...+40 / up to +70 (option) / +3...+70 in PREM TOP+									
temperature resolution [°C]		every 0,1									
controller		microprocessor with external LCD graphic display									
interior	BASIC	aluminum									
	COMF	stainless steel to DIN 1.4016									
	COMF/S	stainless steel to DIN 1.4016									
	PREM (TOP+)	stainless steel to DIN 1.4301									
	PREM/S (TOP+)	stainless steel to DIN 1.4301									
housing	BASIC	powder coated sheet									
	COMF	powder coated sheet									
	COMF/S	polished stainless steel									
	PREM (TOP+)	powder coated sheet									
	PREM/S (TOP+)	polished stainless steel									
overall dims ² [mm]	A width	570	620	620	620	620	620	660	750	1480	1450
	B height	600	860	1060	1260	1460	1860	1990	1990	1990	1970
	C depth	680	650	650	650	650	650	810	860	860	950
internal dims ³ [mm]	D width	430	480	480	480	480	480	430	480	2x480	2x490
	D' width	470	520	520	520	520	520	510	600	1310	1340
	E height	430	660	860	1060	1260	1660	1510	1510	1510	1460
	F depth	300	420	420	420	420	420	650	690	690	750
	F' depth	360	480	480	480	480	480	-	-	-	-
	G depth	-	320	320	320	320	320	-	-	-	-
	H height	-	440	640	840	1050	1440	-	-	-	-
max shelf workload ⁴ [kg]	-	10	10	10	10	10	10	20	30	30	30
	Pw ⁵ version	on request						100	100	100	100
max unit workload [kg]	-	20	30	40	50	60	60	100	150	300	300
	W ⁶ version	on request									
nominal power [W]		160	170	170	330	330	330	400	400	550	550
weight ⁷ [kg]		32	54	59	69	75	90	105	115	185	200
over temperature protection		class 1.0 to DIN 12880 / class 3.3 (option) / class 3.3 in PREM TOP+									
power supply*		230V 50 Hz									
shelves fitted/max		2/2	3/4	3/4	4/6	4/7	4/10	3/11	3/11	2 x 3/11 ⁸	2 x 3/11 ⁸
warranty		24 months									
manufacturer		POL-EKO-APARATURA									

all the above technical data refer to standard units (without optional accessories)

* - 230V 60Hz, 115V 60Hz also available

1 - additional internal glass door

2 - ST 1-6 in TOP+ version are 60 mm higher, depth doesn't include 50 mm of power cable

3 - dims of units with double door can be smaller

4 - on uniformly loaded surface

5 - reinforced shelf

6 - reinforced version







7 - for units in BASIC version with solid door

8 - two columns with 3 shelves each

All data on temperature stability and uniformity available on www.pol-eko.eu.

Options and accessories (icon description see pages 80-81)



		ST 1/1	ST 1/1/1	ST 2/2	ST 2/3	ST 2/4	ST 3/3
Parameter							
air convection		forced					
chamber capacity [l]		70/70	70/70/70	150/150	150/200	150/250	200/200
working capacity [l]		55/55	55/55/55	122/122	122/163	122/203	163/163
door type		solid / glass or double ¹ (option)					
temperature range [°C]		+3...+40 / up to +70 (option) / +3...+70 in PREM TOP+					
temperature resolution [°C]		every 0,1					
controller		microprocessor with external LCD graphic display					
interior		aluminum					
		BASIC					
		COMF					
		COMF/S					
		PREM (TOP+)					
housing		stainless steel to DIN 1.4016					
		COMF					
		COMF/S					
		PREM (TOP+)					
		PREM/S (TOP+)					
overall dims ² [mm]		powder coated sheet					
		COMF					
		COMF/S					
		PREM (TOP+)					
		PREM/S (TOP+)					
internal dims ³ [mm]		A width					
		B height					
		C depth					
		D width					
		D' width					
		E height					
		F depth					
		F' depth					
		G depth					
max shelf workload ⁴ [kg]		H height					
		-					
max unit workload [kg]		10					
		10					
nominal power [W]		320					
weight ⁷ [kg]		480					
over temperature protection		350					
power supply*		350					
shelves fitted/max		350					
warranty		350					
manufacturer		350					

all the above technical data refer to standard units (without optional accessories)

* - 230V 60Hz, 115V 60Hz also available

1 - additional internal glass door

2 - depth doesn't include 50 mm of power cable

3 - dims of units with double door can be smaller

4 - on uniformly loaded surface

All data on temperature stability and uniformity available on www.pol-eko.eu.

5 - reinforced shelf

6 - reinforced version

7 - for units in BASIC version with solid door

Options and accessories (icon description see pages 80-81)

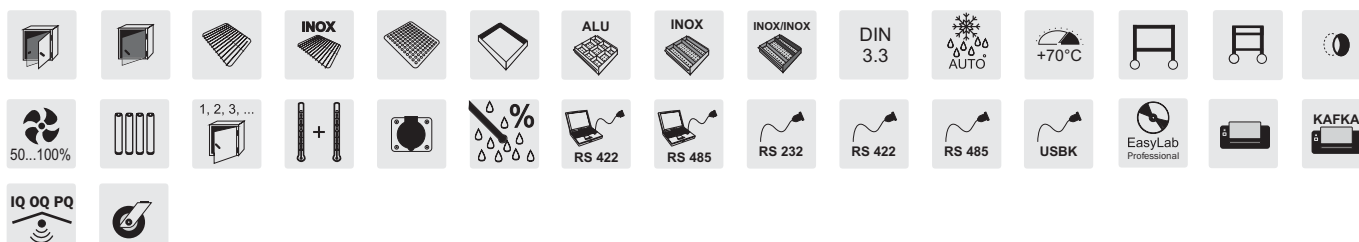

Cooled incubators (ST)

ST

ST 1

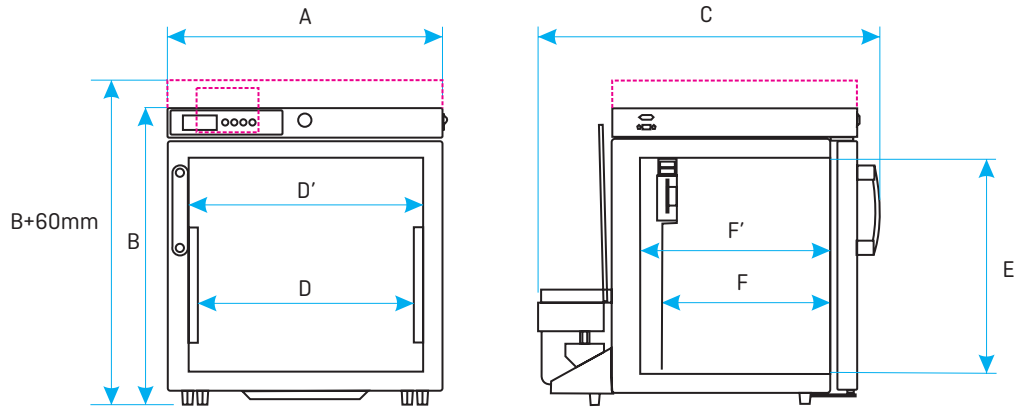

----- - TOP+ version

ST 2/3/4/5/6

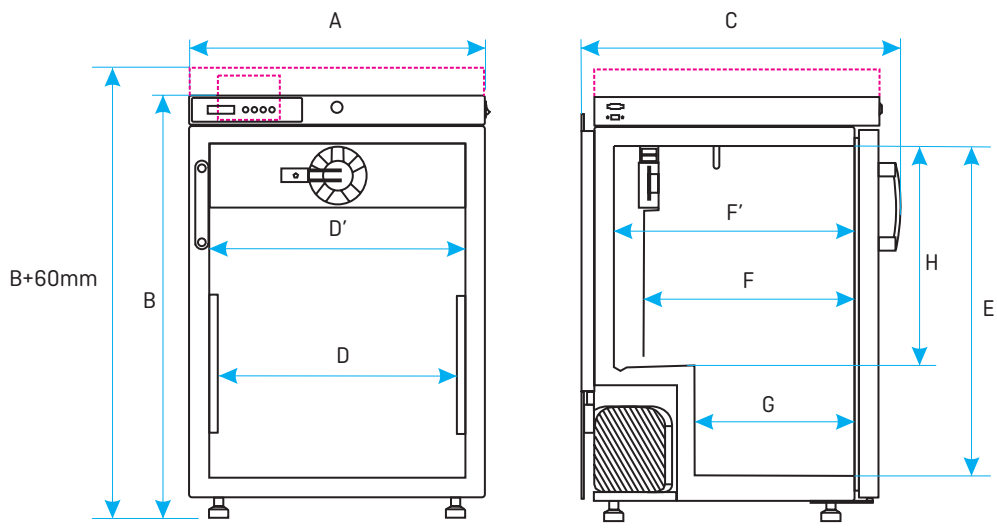

----- - TOP+ version

ST 500/700/1200/1450

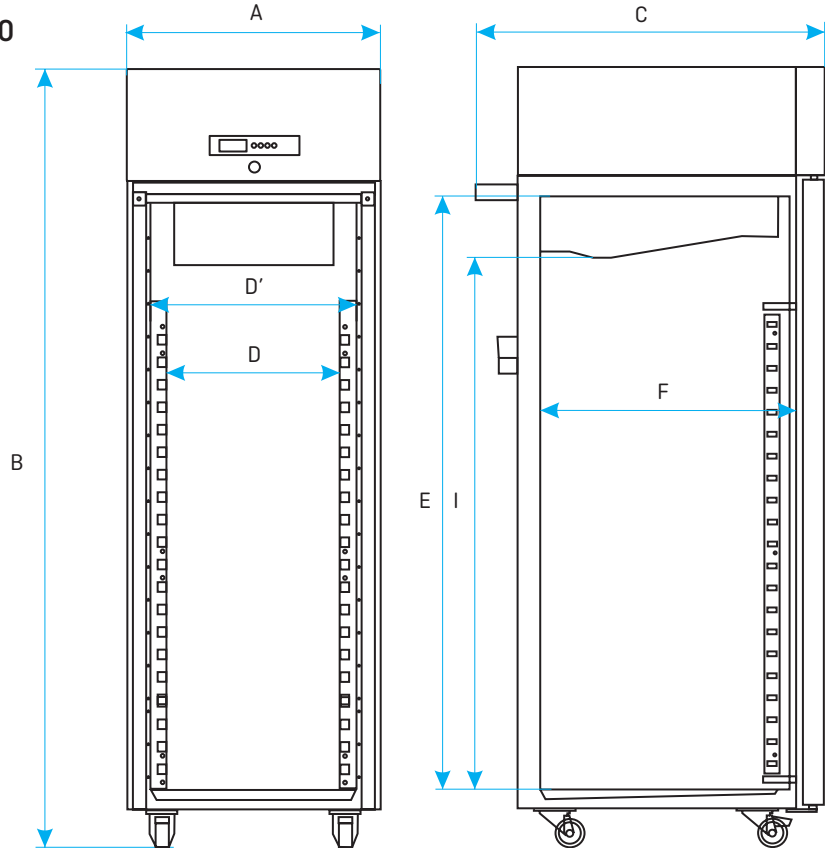

Cooled incubators (ST) with photoperiodic system

▲ Cooled incubators (ST) with photoperiodic system

The photoperiodic (FOT) and phytotron (FIT) systems allow day and night simulation. The FOT option allows the lights to be turned on or off, while the FIT option features additional intensity control.

The BASIC, COMFORT and PREMIUM versions of cooled incubators (ST) can be equipped with the FOT option, while the PREMIUM TOP+ version (ST 500, 700, 1200, 1450) with the FIT system.

▲ Program possibilities with FOT option

- day and night simulation software to control light (on/off), time and temperature separately for each segment
- temperature range for "night" simulation: +3 ... +50°C
- temperature range for "day" simulation: +10 ... +50°C
- lamps installed on side walls
- fluorescent lamp 840 type (daylight) as standard
- operating with time priority (see page 82)

▲ Photoperiodic system (* /FOT option) for single and double chamber cooled incubators (ST)**

Option	ST/FOT2	ST/FOT4	ST/FOT6	ST/FOT8	ST/FOT10	ST/FOT15
available for models	ST1 ST 1/1	ST 2 ST 2/2	ST 2; ST 3 ST 2/2 ST 3/3	ST 4 ST 5	ST 500 ST 700	ST 1200 ST 1450
temperature range with photoperiod ON [°C]	+10 ... +50					
number of lamps on walls	2	4	6	8	10	15 (3 columns with 5 pieces)
adjustable illumination intensity	no	no	no	no	no	no

** for ST models with */FOT option, inner dims can be narrower by 4 cm on each side. FOT option is factory preinstalled. There is no possibility to order it separately.

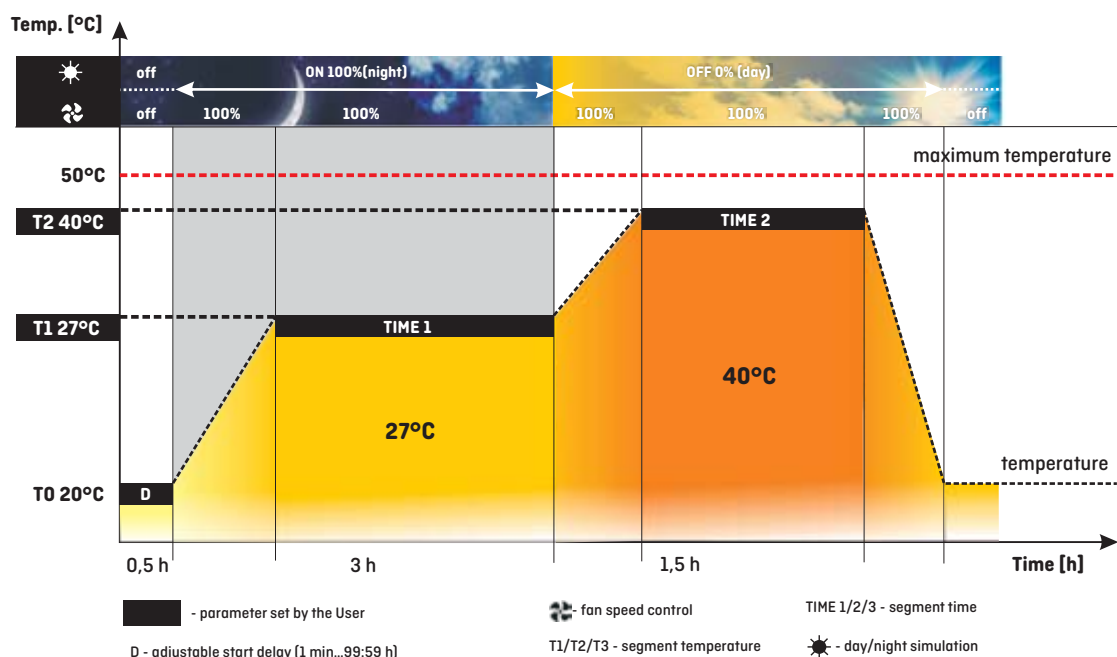

Cooled incubators (ST) with phytotron system

The PREMIUM TOP+ version of cooled incubators (ST 500, 700, 1200, 1450) can be equipped with the FIT system.

Program possibilities with FIT option

- day and night simulation software to control light intensity [%], time temperature and fan speed separately for each segment
- temperature range for „night” simulation: +3...+60°C
- temperature range for „day” simulation: +10... +50°C
- lamps installed in over-shelf panel (FIT P), side walls (FIT S), door (FIT D), door and side walls (FIT DS)
- fluorescent lamp 840 type (daylight) used as standard
- temperature or time priority program (see page 82)

Phytotron system (* /FIT option) for cooled incubators (ST) (PREMIUM TOP+)

Option**	ST/500/700/FIT DS	ST/500/700/FIT P	ST/500/700/FIT S	ST/1200/FIT P	ST/1450/FIT P
temperature range with photoperiod ON [°C]	+10 ... +50°C				
number of over-shelf panels with illumination std/max	-	1/3	-	1/3	1/3
lamps in door	yes	no	no	no	no
lamps in walls	yes	no	yes	no	no
adjustable illumination intensity	yes	yes	yes	yes	yes

** FIT DS - lamps in door and walls; FIT S - lamps in walls; FIT P - over-shelf panels

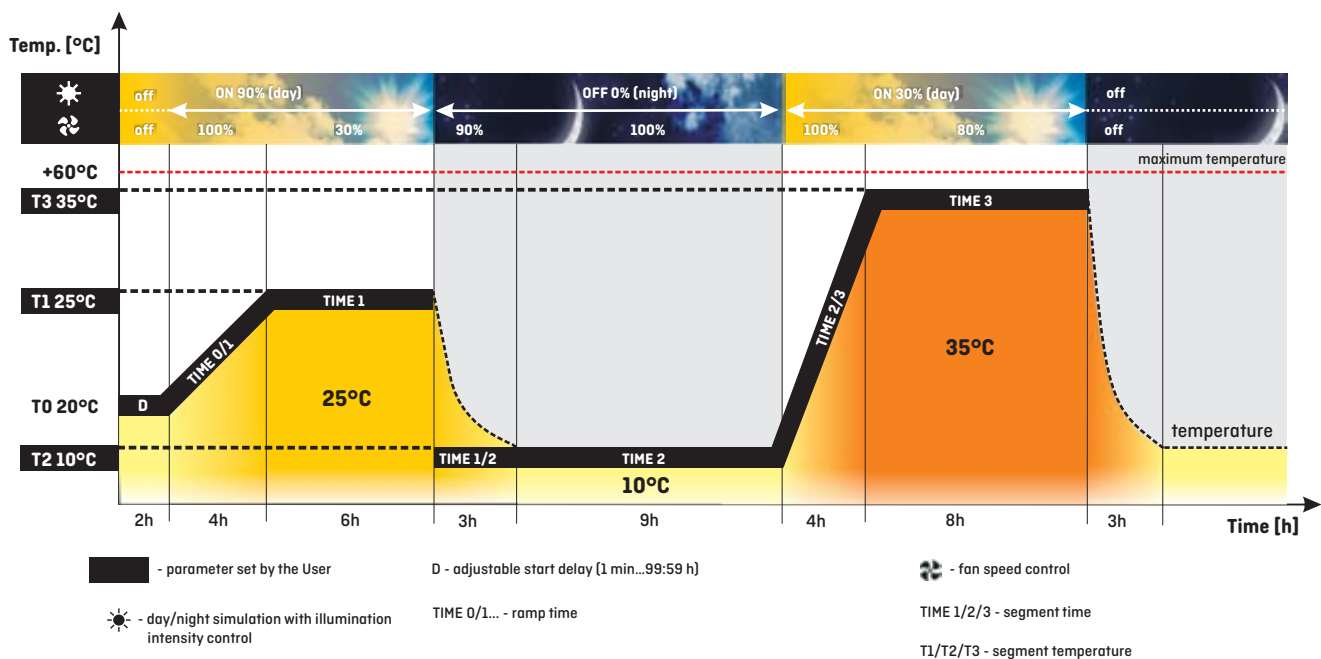

Laboratory refrigerators

Application

- storage of water and sewage samples, piezometer leachate
- storage of AAS, GC or HPLC calibration standards
- storage of reagents
- chemical storage
- storage of medicines and vaccines



Laboratory refrigerators are equipped with a cooling system and can provide a stable temperature between 0°C ... +15°C.

Calibration



All thermostatic equipment manufactured by POL-EKO-APARATURA can be provided with Calibration Certificate issued by accredited Measurement Laboratory. Detailed information on accreditation of POL-EKO Laboratorium Pomiarowe is available on website: www.polekolab.pl.



The **BASIC, COMFORT, PREMIUM** models are equipped with a PID microprocessor controller with an LCD graphic display and illuminated touch buttons.

Controller advantages

- temperature control
- adjustable start delay feature (1 min...99:59 h)
- adjustable hold at set point time for temperature from 1 min to 31 days or continuous operating
- operating with temperature priority mode
- overview of set and current parameters while operating
- recording of min, average and max temperature value for each segment
- operating with temperature priority mode
- defrosting function
- audible and visual temperature alarm
- temperature sensor fail alarm
- power failure control system (program continued after restoring power)
- real-time clock
- auto-diagnostic function
- internal memory to store up to 2046 data records
- forced air convection with optional fan speed control (50-100%)
- automatic fan shut-down after completing the program

Detailed description of parameters on page 82.

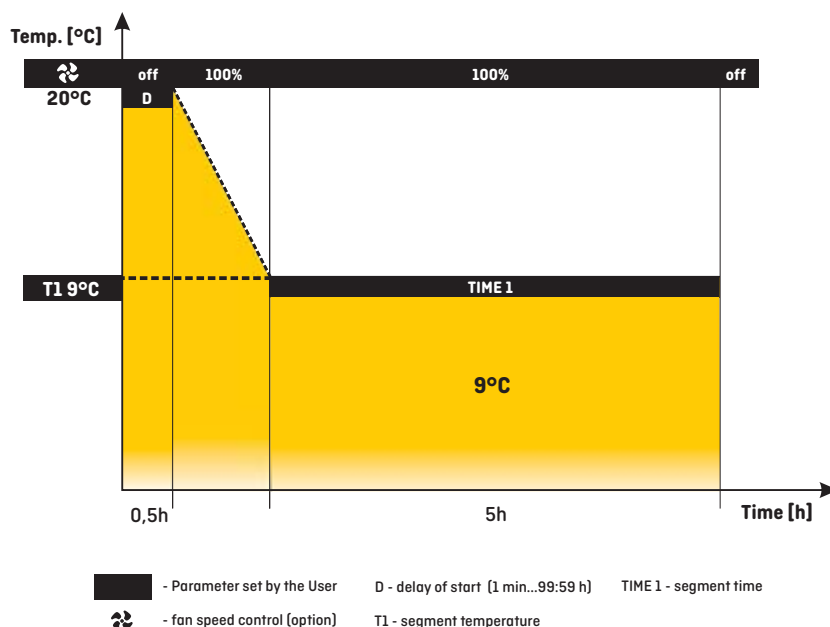

Control panel

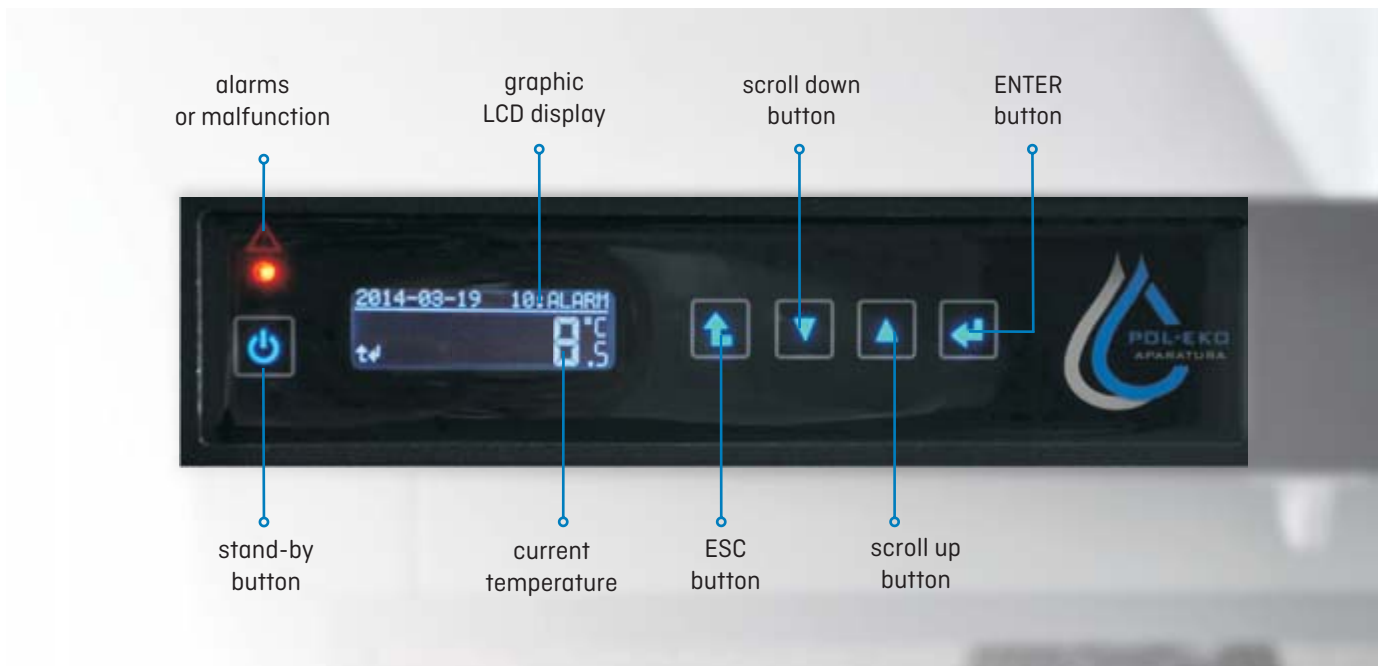

Standard features:

- temperature range 0...+15°C
- quality control protocol (at +4°C)
- operation manual in English
- available menu languages: Czech, English, Estonian, French, German, Italian, Latvian, Polish, Portuguese, Russian, Spanish
- over temperature protection 1.0 class for BASIC and COMFORT models and 2.0 for PREMIUM models according to DIN 12880
- open door alarm
- wheels in standard for models CHL 1200 and 1450

RS 232 and USB ports for data transfer

internal LED light

access port: (Ø 30 mm)

wire shelves with slides set for BASIC and stainless steel wire shelves for COMFORT and PREMIUM models

door lock

solid door

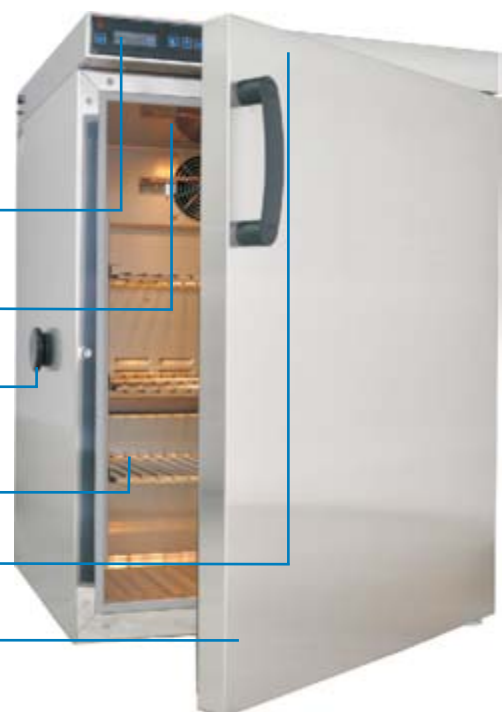

PREMIUM TOP+ version

All the units in TOP+ version are equipped with a PID microprocessor controller with a large [5,7"] full colour touch screen, intuitive menu and user friendly software. They can be connected to Ethernet network for remote control from any computer, being one of the greatest advantages.

Controller advantages

- multi-segment temperature-time profile (up to 100)
- loop function up to 99 times or endless
- adjustable start delay feature (from 1 min to 99:59 h or date/time)
- Administrator function to manage User accounts
- adjustable hold at set point time for temperature from 1 min to 999:59 h or continuous operating
- access control via login
- 7-days programming
- temperature calibration
- adjustable ramps
- overview of set and current parameters while operating
- recording of min, average and max temperature value for each segment
- possibility of temperature calibration by the User
- audible and visual temperature alarm
- operating in temperature or time priority mode
- defrosting function
- temperature sensor fail alarm
- power failure control system (program continued after restoring power)
- digital timer
- real-time clock
- auto-diagnostic function
- forced air convection with fan speed control (50-100%)
- automatic fan shut-down after completing the program

Detailed description of parameters on page 82.

GLP supporting functions

- password protected settings
- 20 user programs memory
- internal memory to store up to 4100 data records for each User, possibility to overview the values on the display or a PC computer in tabular or graphic form
- USB port to allow direct data recording or transfer into a flash drive
- events registry

TOP+ Control application included (see page 68).

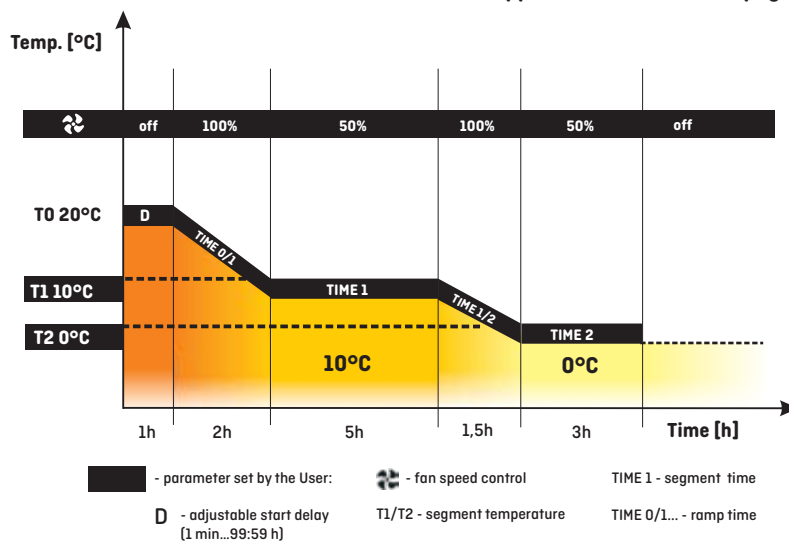

Control panel

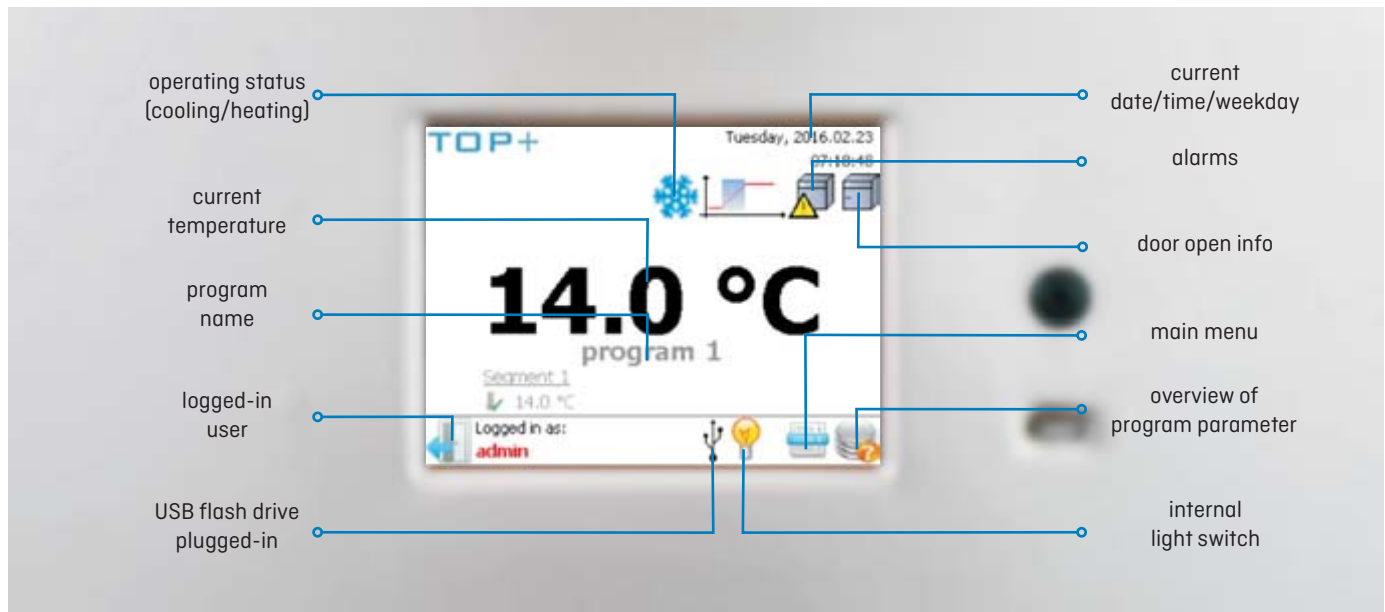

Standard features

- temperature range 0...+15°C
- Ethernet cable
- TOP+ Control software
- quality control protocol (at +4°C)
- English instruction manual
- available menu languages: English, Estonian, French, German, Hungarian, Italian, Latvian, Polish, Portuguese, Romanian, Russian, Spanish
- temperature protection 3.2 class to DIN 12880
- open door alarm
- wheels in standard for models CHL 1200 and 1450

door lock

USB port to allow direct recording and data transfer onto a flash drive

RS 232 interface and LAN port

internal LED light

access port: Ø30 mm

stainless steel wire shelves

solid door



Laboratory refrigerators

CHL

		CHL 1	CHL 2	CHL 3	CHL 4	CHL 5	CHL 6	CHL 500	CHL 700	CHL 1200	CHL 1450
Parameter											
air convection		forced									
chamber capacity [l]		70	150	200	250	300	400	500	625	1365	1460
working capacity [l]		55	122	163	203	243	324	386	450	1229	1307
door type		solid / glass or double ¹ (option)									
temperature range [°C]		0...+15					0...+15 / -10...+15 (option)				
temperature resolution [°C]		every 0,1									
controller		microprocessor with external LCD graphic display									
interior	BASIC	aluminum									
	COMF	stainless steel to DIN 1.4016									
	COMF/S	stainless steel to DIN 1.4016									
	PREM (TOP+)	stainless steel to DIN 1.4301									
	PREM/S (TOP+)	stainless steel to DIN 1.4301									
housing	BASIC	powder coated sheet									
	COMF	powder coated sheet									
	COMF/S	polished stainless steel									
	PREM (TOP+)	powder coated sheet									
	PREM/S (TOP+)	polished stainless steel									
overall dims ² [mm]	A width	570	620	620	620	620	620	660	750	1480	1450
	B height	600	860	1060	1260	1460	1860	1990	1990	1990	1970
	C depth	680	650	650	650	650	650	810	860	860	950
internal dims ³ [mm]	D width	430	480	480	480	480	480	430	480	2x480	2x490
	D' width	470	520	520	520	520	520	510	600	1310	1340
	E height	430	660	860	1060	1260	1660	1510	1510	1510	1460
	F depth	300	420	420	420	420	420	650	690	690	750
	F' depth	360	480	480	480	480	480	-	-	-	-
	G depth	-	320	320	320	320	320	-	-	-	-
	H height	-	440	640	840	1050	1440	-	-	-	-
	J height	-	-	-	-	-	-	1380	1360	1360	1300
max shelf workload ⁴ [kg]	-	10	10	10	10	10	10	20	30	30	30
	Pw ⁵ version	on request						100	100	100	100
max unit workload [kg]	-	20	30	40	50	60	60	100	150	300	300
	W ⁶ version	on request									
nominal power [W]		160	170	170	330	330	330	400	400	550	550
weight ⁷ [kg]		32	54	59	69	75	90	105	115	185	200
over temperature protection		class 1.0 to DIN 12880 / class 3.2 (option) / class 3.2 in PREM TOP+									
power supply*		230 V 50 Hz									
shelves fitted/max		2/2	3/4	3/4	4/6	4/7	4/10	3/11	3/11	2 x 3/11 ⁸	2 x 3/11 ⁸
warranty		24 months									
manufacturer		POL-EKO-APARATURA									

all the above technical data refer to standard units (without optional accessories)

* - 230V 60Hz, 115V 60Hz also available

1 - additional internal glass door

2 - CHL 1-5 in TOP+ version are 60 mm higher, depth doesn't include 50 mm of power cable

3 - dims of units with double door can be smaller

4 - on uniformly loaded surface

5 - reinforced shelf

6 - reinforced version

7 - for units in BASIC version with solid door

8 - two columns with 3 shelves each

All data on temperature stability and uniformity available on www.pol-eko.eu.

Options and accessories (icon description see pages 80-81)

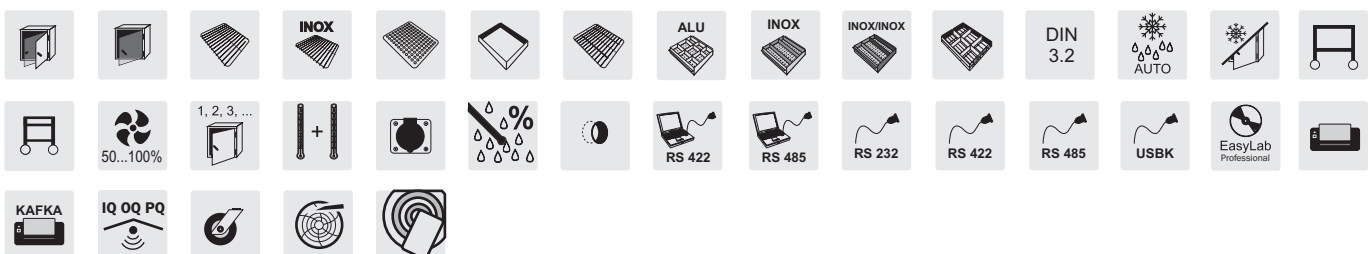

		CHL 1/1	CHL 1/1/1	CHL 2/2	CHL 2/3	CHL 2/4	CHL 3/3	
Parameter								
air convection		forced						
chamber capacity [l]		70/70	70/70/70	150/150	150/200	150/250	200/200	
working capacity [l]		55/55	55/55/55	122/122	122/163	122/203	163/163	
door type		solid / glass or double ¹ (option)						
temperature range [°C]		0...+15						
temperature resolution [°C]		every 0,1						
controller		microprocessor with external LCD graphic display						
interior		aluminum						
		BASIC						
		COMF						
		COMF/S						
		PREM (TOP+)						
housing		powder coated sheet						
		COMF						
		COMF/S						
		PREM (TOP+)						
		PREM/S (TOP+)						
overall dims ² [mm]		A width	570	570	620	620	620	
		B height	1170	1740	1680	1880	2080	2080
		C depth	680	680	650	650	650	650
internal dims ³ [mm]		D width	430	480	480	480	480	
		D' width	470	520	520	520/520	520/520	520
		E height	430	430	660	660/860	660/1060	860
		F depth	300	420	420	420	420	420
		F' depth	360	480	480	480/480	480/480	480
		G depth	-	320	320	320	320	320
		H height	-	440	640	840	1050	1440
max shelf workload ⁴ [kg]		-	10	10	10	10	10	
		Pw ⁵ version	on request					
max unit workload [kg]		-	20	20	30	30/40	30/50	
		W ⁶ version	on request					
nominal power [W]		320	480	350	350	350	350	
weight ⁷ [kg]		65	98	109	114	124	119	
over temperature protection		class 1.0 to DIN 12880 / class 3.2 (option) / class 3.2 in PREM TOP+						
power supply*		230 V 50 Hz						
shelves fitted/max		see table for single chamber models						
warranty		24 months						
manufacturer		POL-EKO-APARATURA						

all the above technical data refer to standard units (without optional accessories)

* - 230V 60Hz, 115V 60Hz also available

1 - additional internal glass door

2 - depth doesn't include 50 mm of power cable

3 - dims of units with double door can be smaller

4 - on uniformly loaded surface

5 - reinforced shelf

6 - reinforced version

7 - for units in BASIC version with solid door

All data on temperature stability and uniformity available on www.pol-eko.eu.

Options and accessories (icon description see pages 80-81)

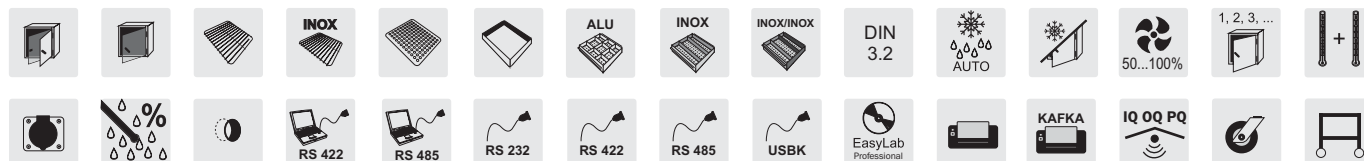

Laboratory refrigerators

CHL

CHL 1

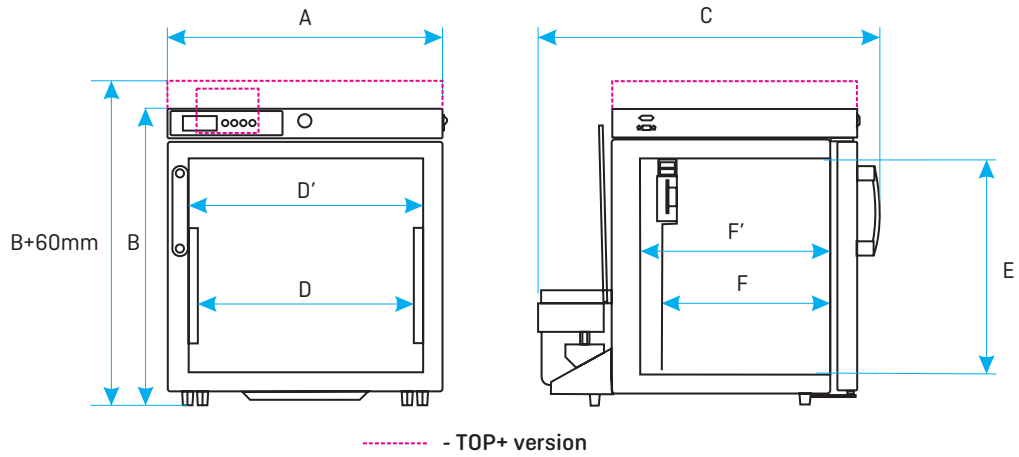

CHL 2/3/4/5/6

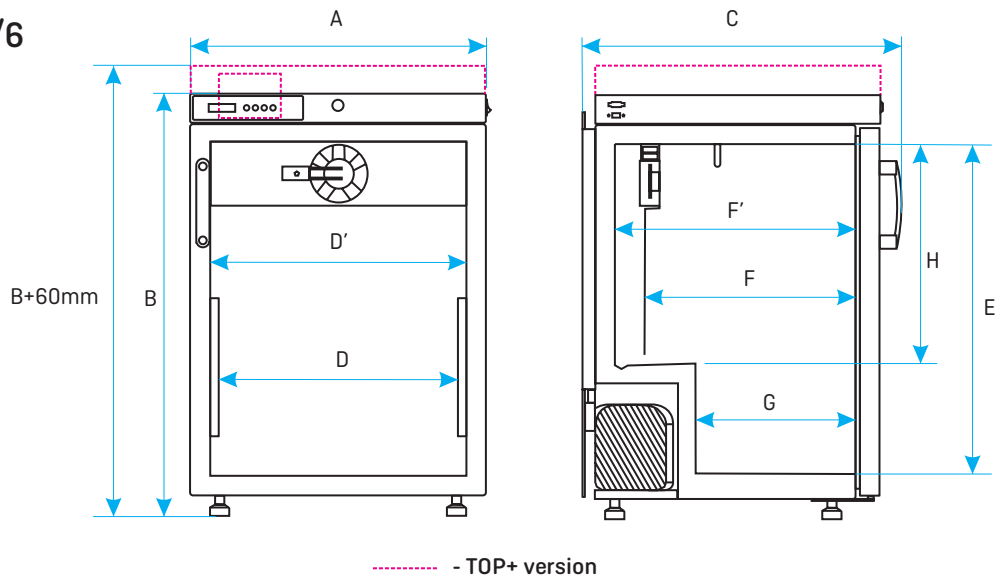

CHL 500/700/1200/1450

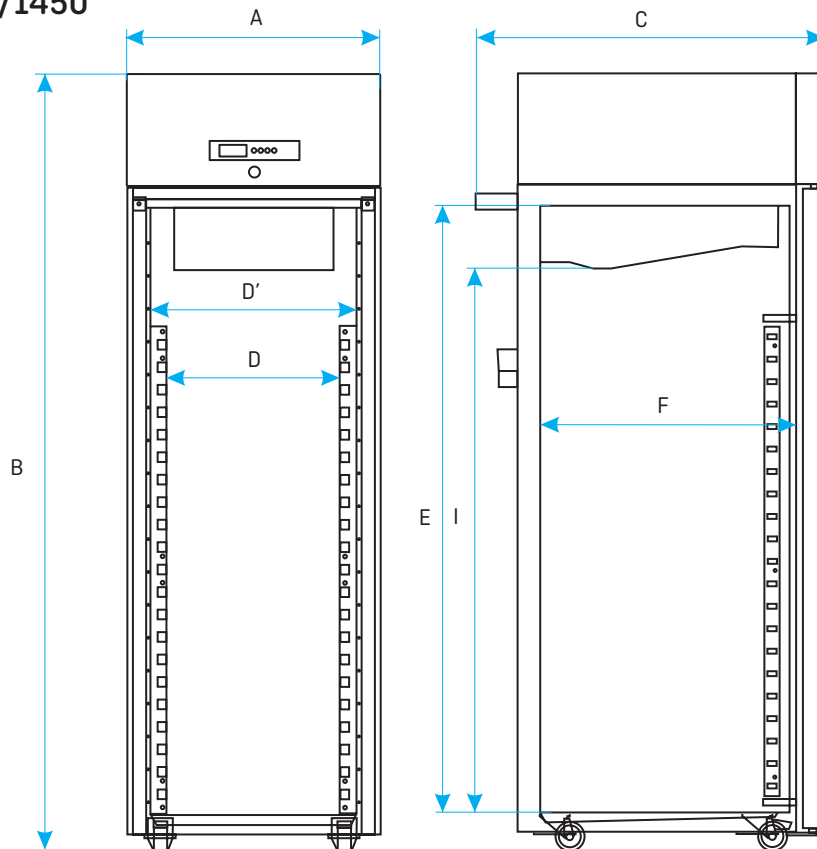

Laboratory freezers

Application

- long-term storage of samples and biological material for research
- storage of easily decomposing material (e.g. solid state)
- freeze resistance tests (e.g. of building materials: concrete, wood etc.)
- pre-freezing
- plasma storage



Laboratory freezers can freeze and store frozen samples.

Calibration



All thermostatic equipment manufactured by P0L-EK0-APARATURA can be provided with Calibration Certificate issued by accredited Measurement Laboratory. Detailed information on accreditation of P0L-EK0 Laboratorium Pomiarowe is available on website: www.polekolab.pl.



The COMFORT and PREMIUM models are equipped with a PID microprocessor controller with an LCD graphic display and illuminated touch buttons.

Controller advantages

- temperature control
- operating with temperature priority
- adjustable start delay feature (1 min...99:59 h)
- loop function up to 99 times or endless
- overview of set and current parameters while operating
- recording of min, average and max temperature value for each segment
- audible and visual temperature alarm
- temperature sensor fail alarm
- power failure control system (program continued after restoring power)
- digital timer
- real-time clock
- auto-diagnostic function
- internal memory to store up to 2046 data records
- natural (ZLN-T) or forced (ZLW-T) air convection

Detailed description of parameters on page 82.

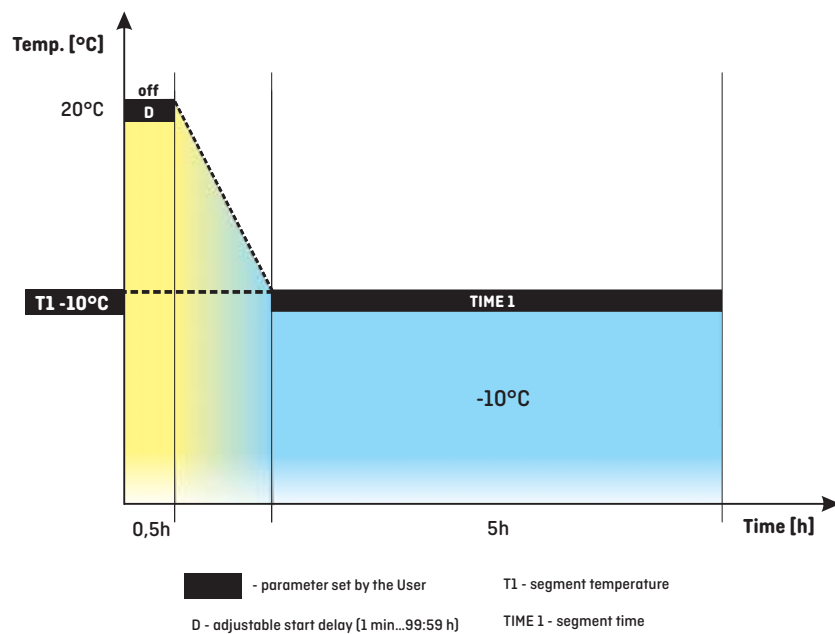

Control panel

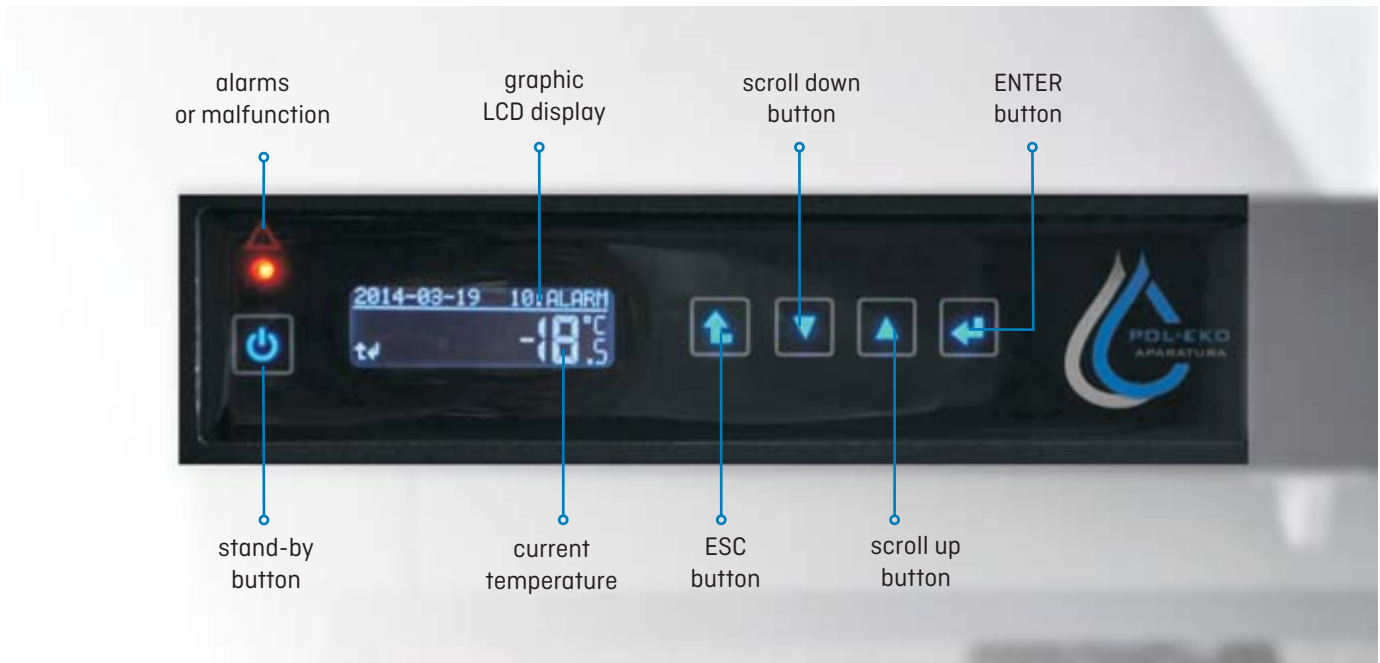

Standard features

- temperature range -25...0°C for ZLN 85 and -40...0°C for ZLN-T 125, 200, 300
- wire stainless steel shelves for ZLN 85 and perforated stainless steel for ZLN-T 125, 200, 300
- quality control protocol (at -20°C)
- English instruction manual
- available menu languages: Czech, English, Estonian, French, German, Italian, Latvian, Polish, Portuguese, Russian, Spanish
- open door alarm

access port: Ø20 mm

door lock







solid door

RS 232 and USB ports for data transfer

internal memory to store up to 2046 data records

wheels in standard for ZLN-T 300



	ZLN 85	ZLN-T 125	ZLN-T 200	ZLN-T 300	<i>new!</i> ZLW-200	<i>new!</i> ZLW-300
Parameter						
air convection	natural			forced		
chamber capacity [l]	95	130	210	310	210	310
working capacity [l]	76	109	180	262	140	213
door type	solid					
temperature range [°C]	-25...0			-40...0		
temperature resolution [°C]	every 0,1					
controller	microprocessor with external LCD graphic display					
interior	COMF	stainless steel to DIN 1.4016				
	COMF/S	stainless steel to DIN 1.4016				
	PREM	stainless steel to DIN 1.4301				
	PREM/S	stainless steel to DIN 1.4301				
housing	COMF	powder coated sheet				
	COMF/S	polished stainless steel				
	PREM	powder coated sheet				
	PREM/S	polished stainless steel				
overall dims ¹ [mm]	A width	610	660	760	760	760
	B height	880	1190	1380	1730	1380
	C depth	650	800	800	800	800
internal dims [mm]	D width	380	370	450	450	450
	D+ width	420	420	520	520	520
	E height	590	600	770	1120	770
	F depth	400	520	520	520	520
	F+ depth	440	530	530	530	530
	G depth	230	-	-	-	-
	I depth	210	-	-	-	-
	J depth	-	-	-	-	600
max shelf workload ² [kg]	-	10	10	10	-	-
	Pw ³ version	-	50	50	50	-
max unit workload [kg]	-	30	50	65	80	-
	W ⁴ version	-	100	130	160	160
nominal power [W]	200	450	470	470	500	500
weight [kg]	60	90	120	185	120	185
power supply*	230 V 50 Hz					
shelves fitted/max	2/4	2/3	2/4	3/6	2/4	3/6
warranty	24 months					
manufacturer	POL-EKO-APARATURA					

all the above technical data refer to standard units (without optional accessories)

- * - 230V 60Hz, 115V 60Hz also available
- 1 - depth doesn't include 50 mm of power cable
- 2 - on uniformly loaded surface
- 3 - reinforced shelf
- 4 - reinforced version

All data on temperature stability and uniformity available on www.pol-eko.eu.

Options and accessories (icon description see pages 80-81)



ZLN 85

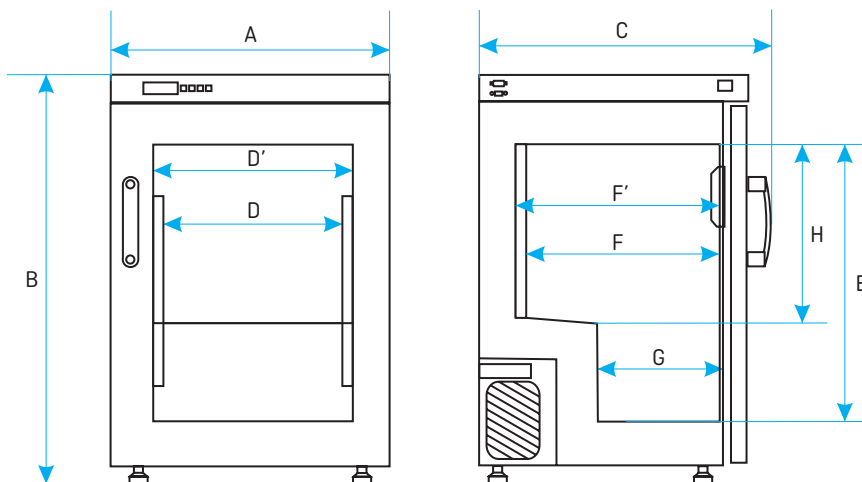

ZLW 200/300

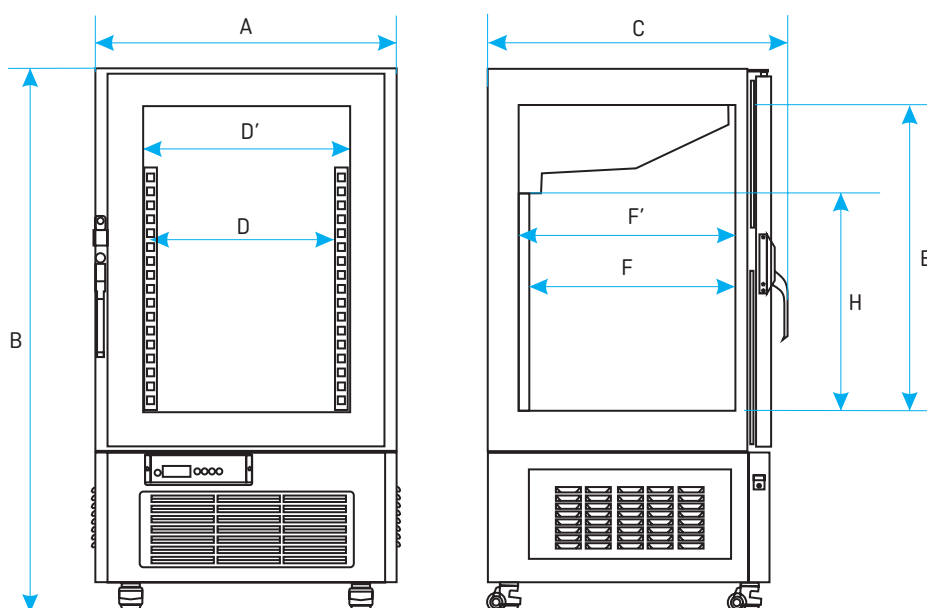

ZLN-T/125/200/300

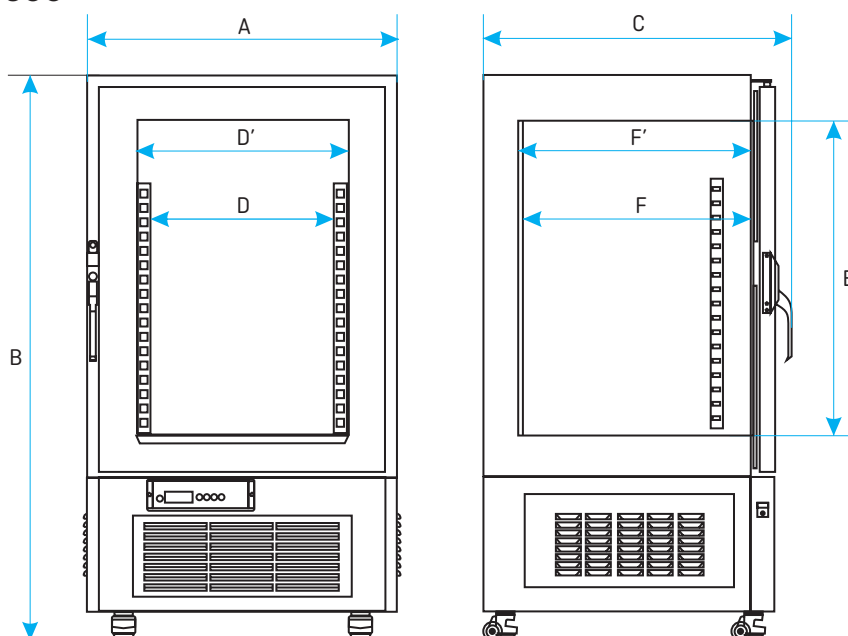

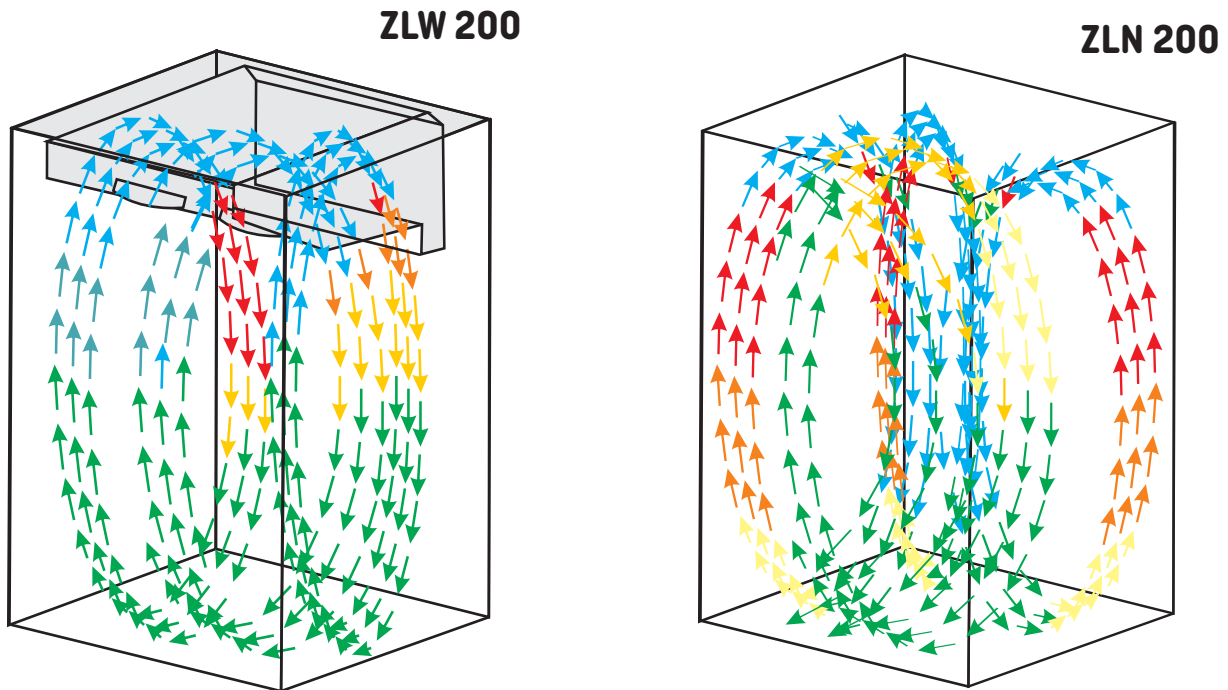

Freezers with forced air convection are “no frost” freezers. The basic principle of such system is to manage humidity inside the unit and prevent frost formation on the walls. The fan in the chamber mechanically forces the air circulation and ensures continuous air exchange. It blows continuously over the cooling element, the air is cooled down and gets into the chamber through special channels. Humid air converts into frost, but is directed to a special evaporator compartment and settles on the coldest element. The compressor periodically turns off, the frost layer melts down by a heating element and is drained outside as a condensate.

Advantages

- Uniform distribution of cool air through the chamber
- No need to defrost the unit
- Faster achieving of set temperature even with a large filling of the chamber
- Stable operation of the unit (in case of natural air convection freezers - the bigger ice layer on the evaporator, the less efficient operation of the unit)

Disadvantages in comparison to natural air convection unit

- Due to continuous operation of fan and dehumidification of the chamber air stored samples may be subject to ‘drying up’. This can be easily prevented by proper packing of material
- Louder operation unit (due to fan noise operation)
- Higher power consumption (due to fan operation)

Ultra-low freezers

Application

- biotechnology
- research
- pharmacy
- storage



Ultra-low freezers are used for deep freezing of biotechnological samples and other materials which should be stored at very low temperature.



Calibration



All thermostatic equipment manufactured by POL-EKO-APARATURA can be provided with Calibration Certificate issued by accredited Measurement Laboratory. Detailed information on accreditation of POL-EKO Laboratorium Pomiarowe is available on website: www.polekolab.pl.

Controller advantages

- temperature range: -86...-40°C
- full stainless steel shelves with hole
- quality control protocol (at -80°C)
- English instruction manual
- available menu languages: Czech, English, Estonian, French, German, Italian, Latvian, Polish, Portuguese, Russian, Spanish
- access port: Ø20 mm
- door lock
- external solid door and internal solid door for each chamber
- wheels
- controller spare batteries in case of power failure - alarm output
- additional port for installation of CO₂ & Pt100 backup

Parameter		ZLN-UT 200	New!	ZLN-UT 300
				
air convection		natural		
chamber capacity [l]		237		326
number of boxes 133x133x50mm [pcs]		108		144
door type		solid		
temperature range [°C]		-86...-40		
temperature resolution [°C]		every 0,1		
cooling time from +20 °C to -80 °C [h]		3,5		3,5
heating time in case of power failure -80 °C to -60 °C [h]		1,5		1,5
controller		microprocessor with external LCD graphic display		
interior	COMF	stainless steel to DIN 1.4016		
	PREM	stainless steel to DIN 1.4301		
housing		powder coated sheet		
overall dims ¹ [mm]	A width	850		850
	B height	1620		1910
	C depth	950		950
internal dims [mm]	D width	520		520
	E height	830		1140
	F depth	550		550
	G height	240		240
max unit workload [kg]		65		80
max shelf workload [kg]		10		10
nominal power [W]		670		670
energy consumption 24h [kWh] at -80°C		16		18
weight [kg]		180		200
power supply*		230 V 50 Hz		
number of internal chambers		3		4
warranty		24 months		
manufacturer		POL-EKO-APARATURA		

all the above technical data refer to standard units (without optional accessories)

* - 230V 60Hz, 115V 60Hz also available

1 - depth doesn't include 50 mm of power cable

All data on temperature stability and uniformity available on www.pol-eko.eu.

Options and accessories (icon description see pages 80-81)



ZLN-UT 200

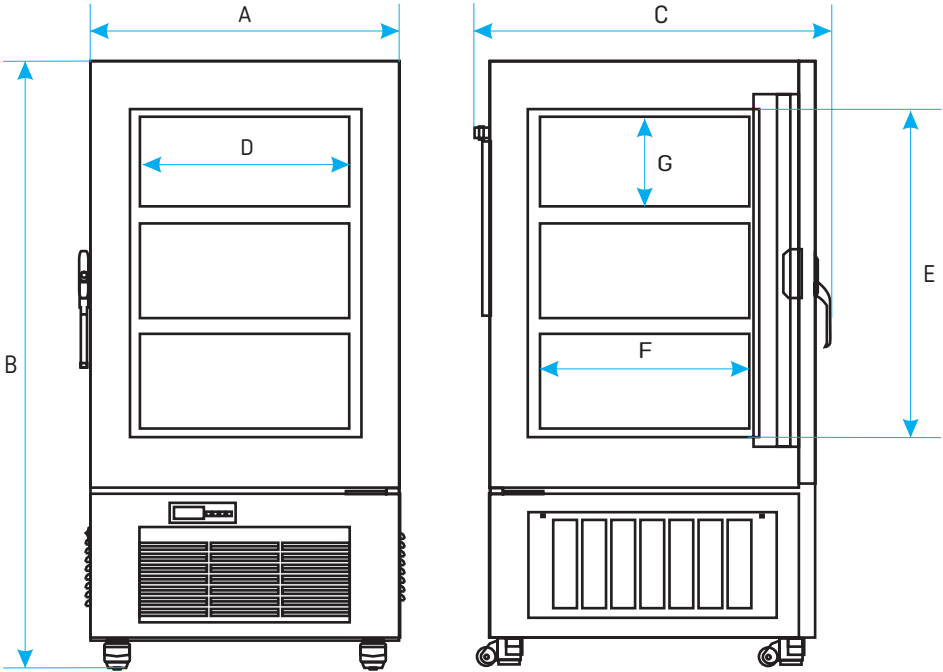

ZLN-UT 300

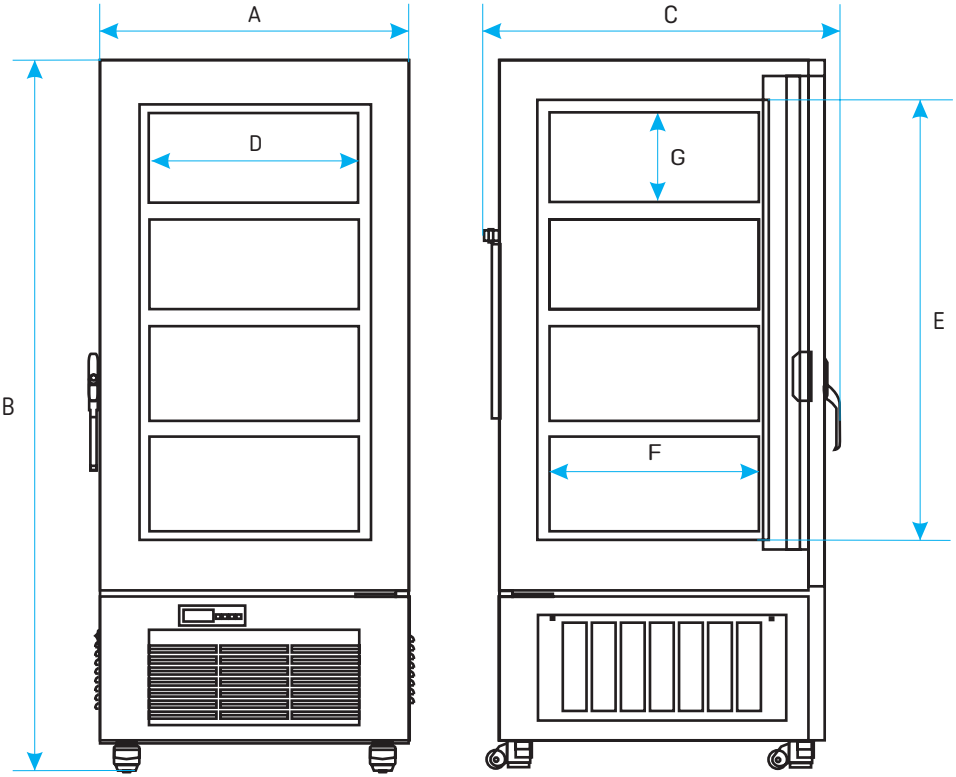

▲ Racks with drawers and boxes for test-tubes for ultra low freezers



Racks with drawers
 sturdy and heavy duty,
 made of stainless steel;
 feature quick and easy
 access to all boxes;
 4 drawers (each for 3 boxes)
 per rack.



Boxes
 made of polypropylene,
 dimensions 133 x 133 x 50 mm;
 each box suits 81 test-tubes
 of Ø12,5 mm

▲ Boxes for test-tubes

Model	compartments	racks per compartment	boxes per rack	boxes per compartment	boxes per unit	test-tubes per unit
ZLN-UT 200	3	3	12	36	108	8 748
ZLN-UT 300	4	3	12	36	144	11 664

Drying ovens, incubators, cooled incubators

All the units in the STD version are equipped with a PID microprocessor controller with an LCD graphic display and illuminated touch buttons.

Controller advantages

- six-segment temperature-time profile
- loop function up to 99 times or endless
- 3 user programs memory
- adjustable start delay feature (from 1 min to 99:59 h)
- adjustable hold at set point time for temperature and lighting (for IL/FOT) from 1 min to 100 days, or continuous operating
- adjustable ramps
- overview of set and current parameters while operating
- recording of min, average and max temperature value for each segment
- possibility of temperature calibration by the user
- audible and visual temperature alarm
- operating with temperature priority
- temperature sensor fail alarm
- power failure control system (program continued after restoring power)
- digital timer
- real time clock
- auto-diagnostic function
- internal memory to store up to 2046 data records
- natural (SL/SR/CL) or forced (SL/SR/CL/IL) air convection with fan speed control (for CLW/SLW/SRW 15-115 0 ... 100%, CLW/SLW/SRW 180-1000 and ILW 10 ... 100%)
- automatic fan shut-down after completing the program
- automatic air-flap control (CL/SL/SR)

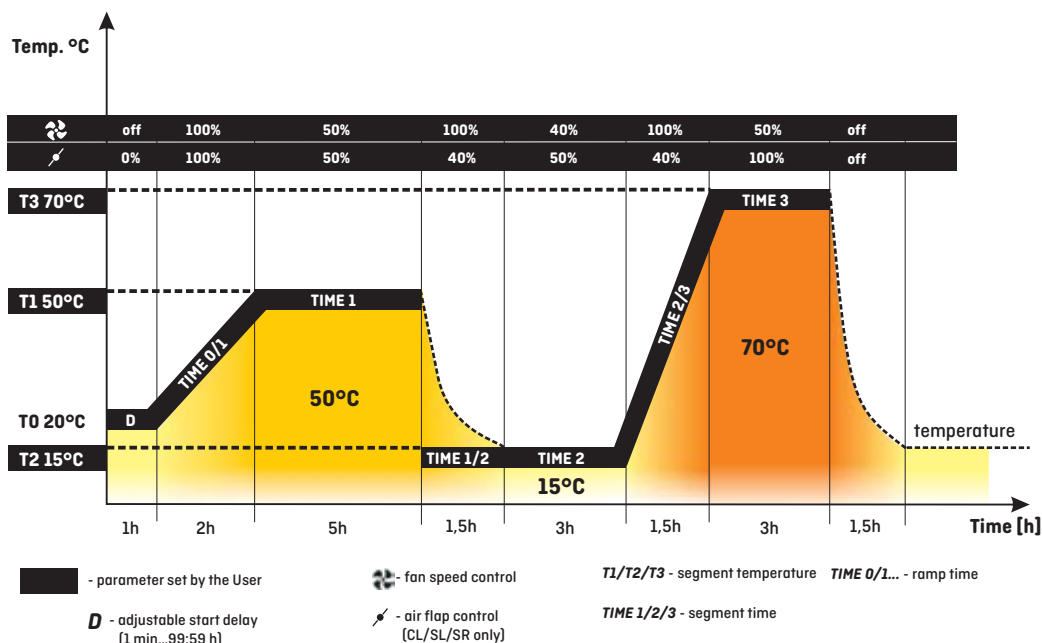

Control panel

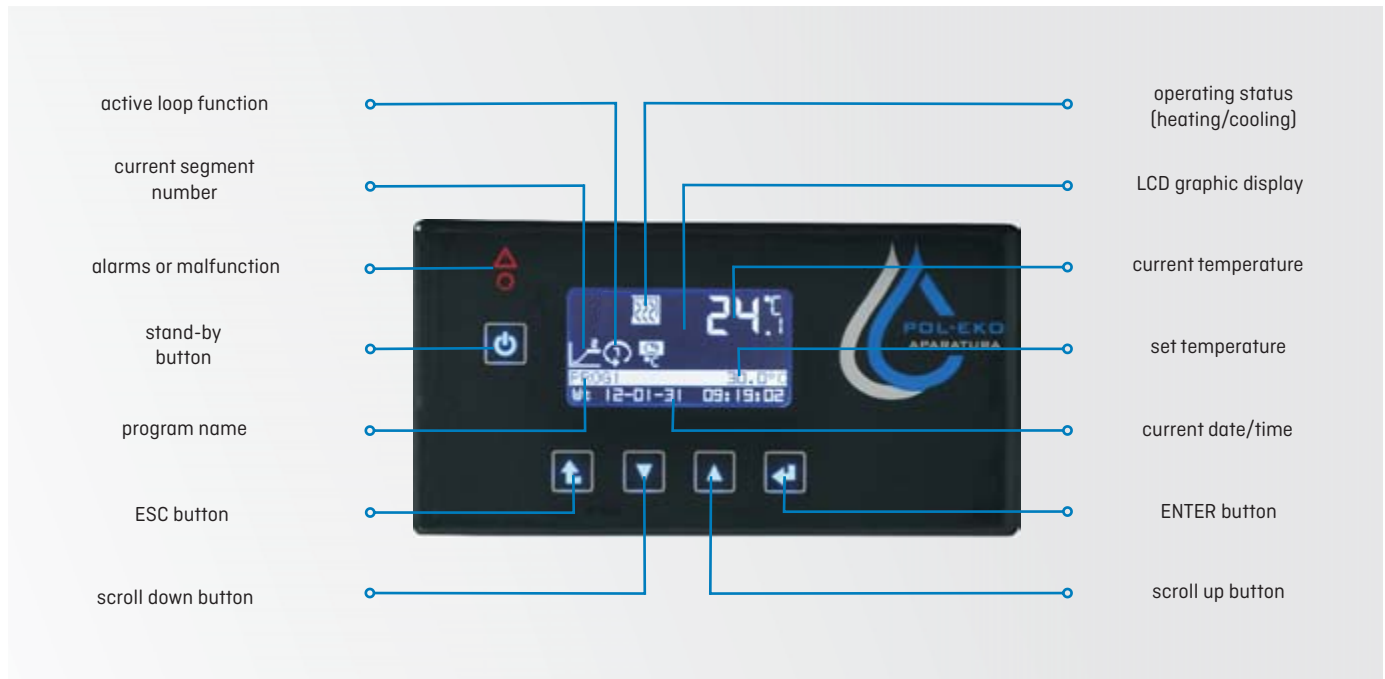

Standard features

- temperature range: SL [+5°C above ambient temp. ... +300°C], SR [+5°C above ambient temp. ... +250°C], CL [+5°C above ambient temp. ... +100°C], IL [0°C up to 70°C / optionally -10°C up to 70°C]
- quality control protocol (at +37°C for CL/IL, at +105°C for SL, at +170°C for SR)
- English instruction manual
- available menu languages: Czech, English, Estonian, French, German, Italian, Polish, Portuguese, Russian, Spanish
- temperature protection class 2.0 to DIN 12880
- open door alarm
- wheels in standard for models 750, 1000, ILW 400

RS232 and USB ports for data transfer

access port: Ø30 mm for models 53-1000 or Ø9 mm for models 15-32

wire stainless steel shelves

solid door, internal glass door for CL and IL

door lock



TOP+ version

All the units in the TOP+ version are equipped with a PID microprocessor controller with a large (5,7") full colour touch screen, intuitive menu and user friendly software. They can be connected to Ethernet network for remote control from any computer, being one of the greatest advantages.

Controller advantages

- multi-segment temperature-time profile (up to 100)
- Administrator function to manage User accounts
- adjustable start delay feature (from 1 min to 99:59 h)
- access control via login
- 7 days programming
- loop function up to 99 times or endless
- adjustable hold at set point time for temperature and lighting (for IL/FIT) from 1 min to 999:59 h, or continuous operating
- adjustable ramps
- overview of set and current parameters while operating
- recording of min, average and max temperature value for each segment
- possibility of temperature calibration by the User
- audible and visual temperature alarm
- operating in temperature or time priority mode
- temperature sensor fail alarm
- power failure control system (program continued after restoring power)
- digital timer
- real time clock
- auto-diagnostic function
- natural (SL/CL) or forced (SL/CL/IL) air convection with fan speed control for CLW/SLW 53/115 0...100%; CLW/SLW 180-1000 and ILW 10...100%
- automatic fan shut-down after completing the program
- automatic air-flap control (CL/SL)

GLP supporting functions

- password protected settings
- 20 user programs memory
- internal memory to store up to 4100 data records for each User, possibility to overview the values on the display or a PC computer in tabular or graphic form
- USB port to allow direct data recording or transfer onto a flash drive
- events registry

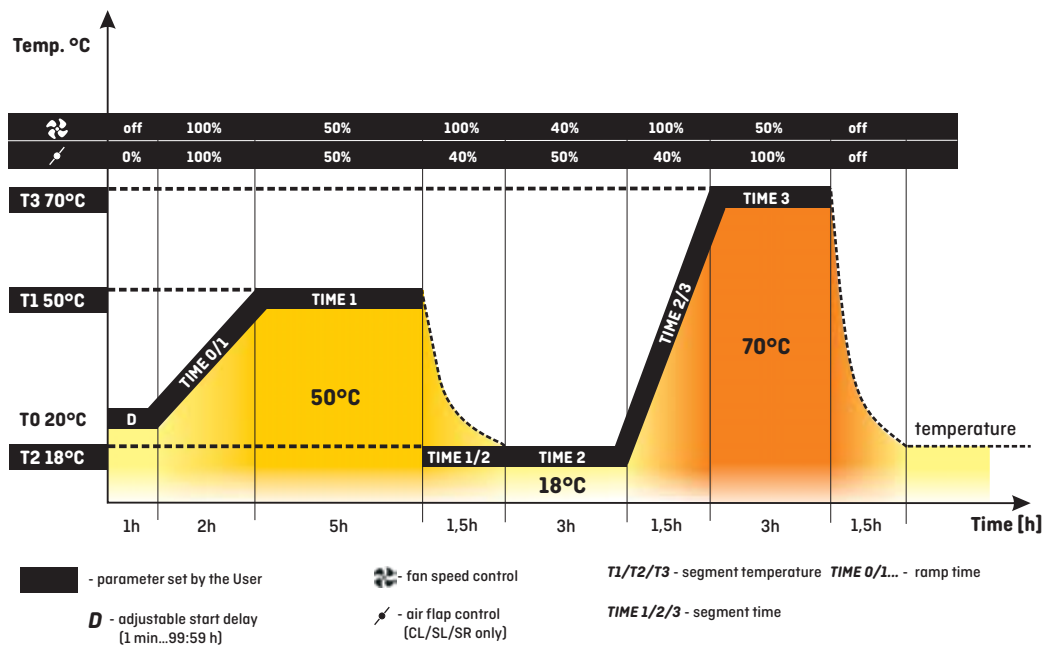

Control panel

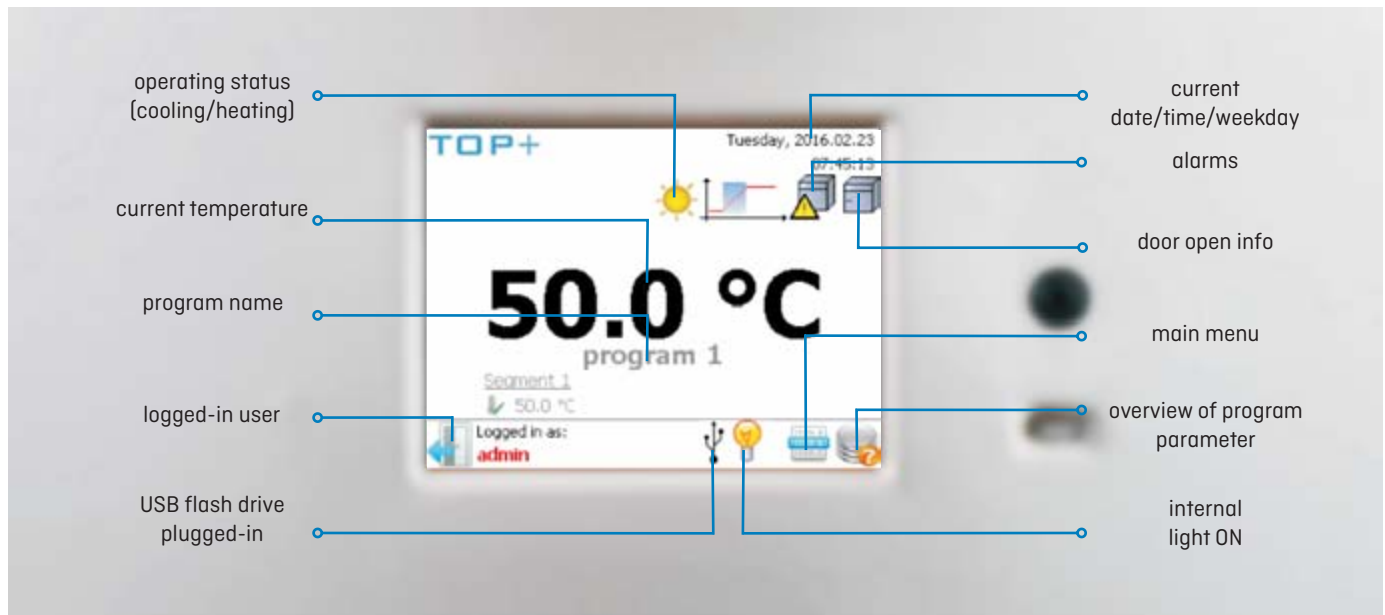

Standard features

- temperature range: SL (+5°C above ambient temp. ... +300°C), CL (+5°C above ambient temp. ...+100°C), IL (0°C up to 100°C / optionally -10°C up to 100°C)
- Ethernet cable
- TOP+ Control software
- USB port to allow direct recording and data transfer onto a flash drive
- quality control protocol (at +37°C for CL/IL, at +105°C for SL)
- English instruction manual
- available menu languages: English, Estonian, French, German, Hungarian, Italian, Latvian, Polish, Portuguese, Romanian, Russian, Spanish
- temperature protection class 3.3 (IL), class 3.1 (CL/SL) to DIN 12880
- open door alarm
- wheels in standard for models 750, 1000

RS232 interface

Ethernet port for remote control

access port: Ø30 mm

wire stainless steel shelves

solid door, internal glass door for CL and IL

door lock



Laboratory incubators

Application

- incubation of samples for microbiological determinations
- analysis of thermal resistance of samples subjected to higher temperatures
- antibodies tests
- bacteria tests
- crystallization observations
- cultivation of thermophilic microorganisms
- pharma stability tests
- food industry denaturalizing tests



Laboratory incubators are perfect for incubation of samples at temperatures above ambient up to +100°C.

Calibration



All thermostatic equipment manufactured by POL-EKO-APARATURA can be provided with Calibration Certificate issued by accredited Measurement Laboratory. Detailed information on accreditation of POL-EKO Laboratorium Pomiarowe is available on website: www.polekolab.pl.

		CL 15	CL 32	CL 53	CL 115	CL 180	CL 240	CL 400	CL 750	CL 1000
Parameter										
air convection		natural [CLN] / forced [CLW]						forced [CLW]		
chamber capacity ¹ [l]		15	32	56	112	180	245	424	749	1005
door type		double			double/door with viewing window (option)					
temperature range		+5°C above ambient temperature ...+100°C								
temperature resolution [°C]		every 0,1								
controller		microprocessor with external LCD graphic display								
interior		acid-proof stainless steel to DIN 1.4301								
housing	-	powder coated sheet								
	INOX/G	stainless steel linen finish								
overall dims ² [mm]	A width	510	590	590	650	650	810	1010	1260	1260
	B height	550	630	700	850	1030	1200	1430	1600	2000
	C depth	440	500	600	700	760	760	750	850	850
internal dims [mm]	D width	320	400	400	460	470	600	800	1040	1040
	E height	230	320	390	540	720	800	1040	1200	1610
	F depth	200	250	360	450	560	510	510	600	600
max shelf workload ⁵ [kg]	-	10	10	25	25	25	25	25	-	-
	PW ³ version	-	-	50	50	50	100	100	100	100
max unit workload [kg]	-	20	30	40	60	75	90	120	140	-
	W ⁴ version	-	-	80	120	120	300	300	300	300
nominal power [W]		300	300	400	400	850	800	1200	1800	1800
weight [kg]		27	35	50	65	94	126	174	260	330
over temperature protection		class 2.0 according to DIN 12880 / class 3.1 (option) / 3.1 in TOP+								
power supply*		230 V 50 Hz								
shelves fitted/max		1/2	1/3	2/5	2/7	3/9	3/10	3/14	5/16	6/22
warranty		24 months								
manufacturer		POL-EKO-APARATURA								

all the above technical data refer to standard units (without optional accessories)

* - 230V 60Hz, 115V 60Hz also available

1 - working capacity of chamber can be smaller

2 - depth doesn't include 50 mm of power cable

3 - reinforced shelf

4 - reinforced version

5 - on uniformly loaded surface

All data on temperature stability and uniformity available on www.pol-eko.eu.

Options and accessories (icon description see pages 80-81)

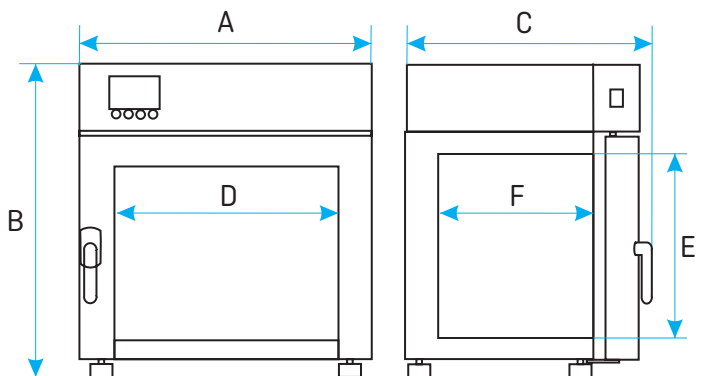

Cooled incubators

Application

- microbiological tests
- plant growing, microorganisms breeding at precisely controlled environment
- BOD determination
- incubation of samples at specified temperature



Cooled incubators are perfect for incubation of samples in a stable environment, regardless of ambient conditions, at temperatures from -10 up to +100°C.

Calibration



All thermostatic equipment manufactured by POL-EKO-APARATURA can be provided with Calibration Certificate issued by accredited Measurement Laboratory. Detailed information on accreditation of POL-EKO Laboratorium Pomiarowe is available on website: www.polekolab.pl.

Cooled incubators

IL

		ILW 53	ILW 115	ILW 240	ILW 400	ILW 750
air convection		forced				
chamber capacity ¹ [l]		56	112	245	424	749
door type		double/door with viewing window (option)				
temperature range [°C]		-10 (option)/ 0...+70 (+100 for TOP+ version)				
temperature resolution [°C]		every 0,1				
controller		microprocessor with external LCD graphic display				
interior		acid-proof stainless steel to DIN 1.4301				
housing	- -	powder coated sheet				
	INOX/G	stainless steel linen finish				
overall dims ² [mm]	A width	690	660	820	1040	1260
	B height	960	1080	1430	1650	1820
	C depth	600	710	760	740	860
internal dims [mm]	D width	400	460	600	800	1040
	E height	390	540	800	1040	1200
	F depth	360	450	510	510	600
max shelf workload ⁵ [kg]	-	25	25	25	25	25
	PW ³ version	50	50	100	100	100
max unit workload [kg]	-	40	60	90	120	140
	W ⁴ version	80	120	300	300	300
nominal power [W]		400	400	800	1200	1800
weight [kg]		69	90	140	185	275
over temperature protection		class 2.0 according to DIN 12880 / class 3.3 (option) / 3.3 in TOP+				
power supply*		230 V 50 Hz				
shelves fitted		2/5	2/7	3/10	3/14	5/16
warranty		24 months				
manufacturer		POL-EKO-APARATURA				

all the above technical data refer to standard units (without optional accessories)

* - 230V 60Hz, 115V 60Hz also available

1 - working capacity of chamber can be smaller

2 - depth doesn't include 50 mm of power cable

3 - reinforced shelf

4 - reinforced version

5 - on uniformly loaded surface

All data on temperature stability and uniformity available on www.pol-eko.eu.

Options and accessories (icon description see pages 80-81)

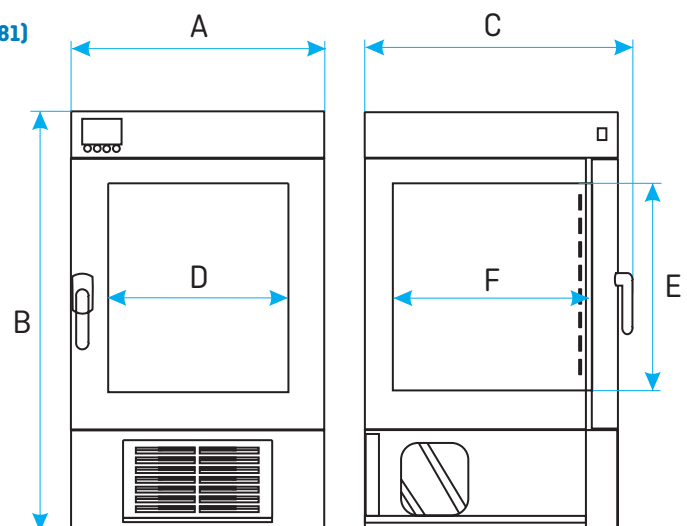
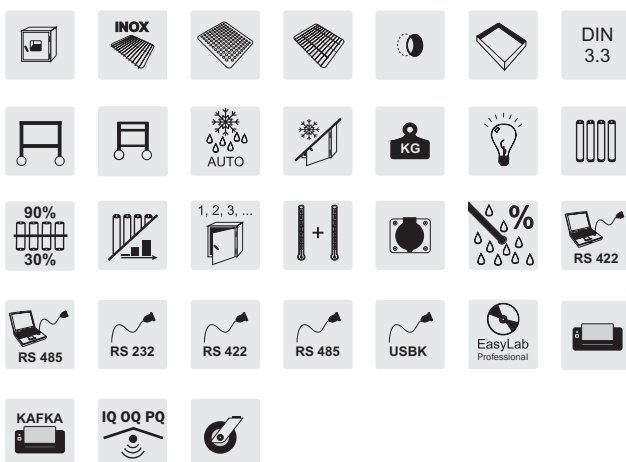



Innovative and ecological ILP Peltier-cooled incubators

Advantages over compressor-cooled incubators



Quiet operation

The noise generated by the unit has been limited significantly to create more comfortable working conditions in the laboratory.



Environmentally friendly

Elimination of compressor and refrigerants ensures environmental protection.



Lighter and smaller

The Peltier-element system has reduced the size and weight of the unit.



Vibration-free

With the introduction of the Peltier-element system, vibrations previously generated by the compressor have been eliminated.



Energy-saving

The Peltier technology has reduced the power consumption considerably to make the ILP incubators even more energy-efficient.



Perfect performance



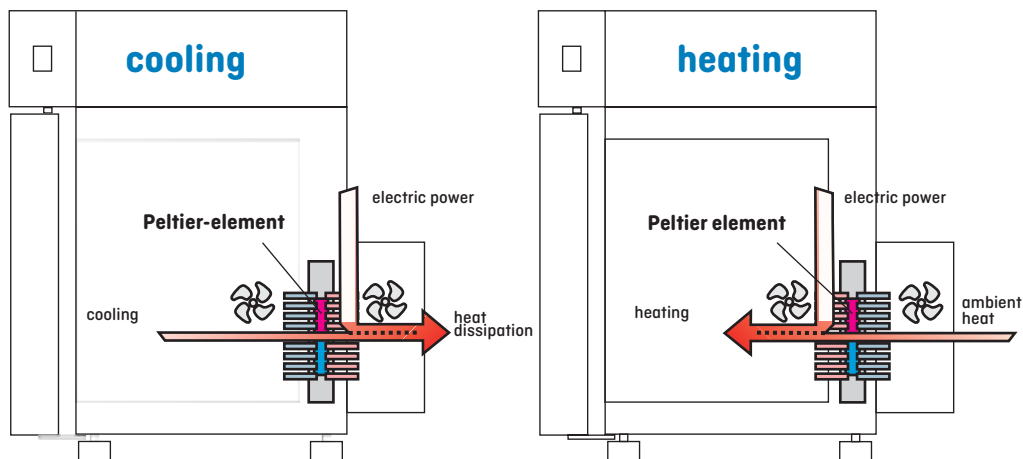

The cooling system based on the Peltier-element features excellent temperature stability and uniformity. It also improves the temperature recovery time [e.g. after door opening].



Calibration



All thermostatic equipment manufactured by POL-EKO-APARATURA can be provided with Calibration Certificate issued by accredited Measurement Laboratory. Detailed information on accreditation of POL-EKO Laboratorium Pomiarowe is available on website: www.polekolab.pl.

		ILP 53	ILP 115	ILP 240	ILP 400
Parameter					
air convection		forced			
chamber capacity [l]		56	112	245	424
door type		double / door with viewing window (option)			
temperature range [°C]		+15...+70 (+100 for TOP+ version)			
temperature resolution [°C]		every 0.1			
controller		microprocessor with external LCD graphic display			
interior		stainless steel to DIN 1.4301			
housing		powder coated sheet			
		INOX/G			
		stainless steel linen finish			
overall dims [mm]	A width	600	660	820	1040
	B height	710	850	1140	1380
	C depth	660	770	810	840
internal dims [mm]	D width	400	460	600	800
	E height	390	540	800	1040
	F depth	360	450	510	510
max shelf workload ² [kg]	-	25	25	25	25
	PW ¹ version	50	50	100	100
max unit workload [kg]		40	60	90	90
nominal power [W]		400	400	800	800
weight [kg]		69	90	140	190
over temperature protection		class 2.0 to DIN 12880 / class 3.3 (option) / class 3.3 in TOP+			
power supply*		230 V 50 Hz			
shelves fitted/max		2/5	2/7	3/10	3/14
warranty		24 months			
manufacturer		POL-EKO-APARATURA			

all the above technical data refer to standard units (without optional accessories)

* - 230V 60Hz, 115V 60Hz also available

1 - reinforced shelf

2 - on uniformly loaded surface

All data on temperature stability and uniformity available on www.pol-eko.eu.

Options and accessories (icon description see pages 80-81)

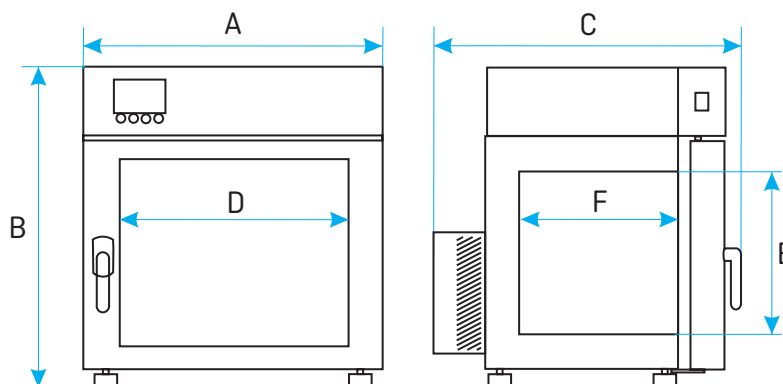

Cooled incubators with phytotron system

The TOP+ version of cooled incubators (models ILW 115, 240, 400,750) can be equipped with the FIT system.

Program possibilities with FIT option

- day and night simulation software to control light intensity [%], time, temperature and fan speed separately for each segment
- temperature range for "night": -10°C up to +60°C (with IL/T option)
- temperature range for "day": +10°C up to + 50°C
- lamps installed in over-shelf panels
- fluorescent lamp 840 type (daylight) used as standard
- operating with temperature or time priority (see page 82)

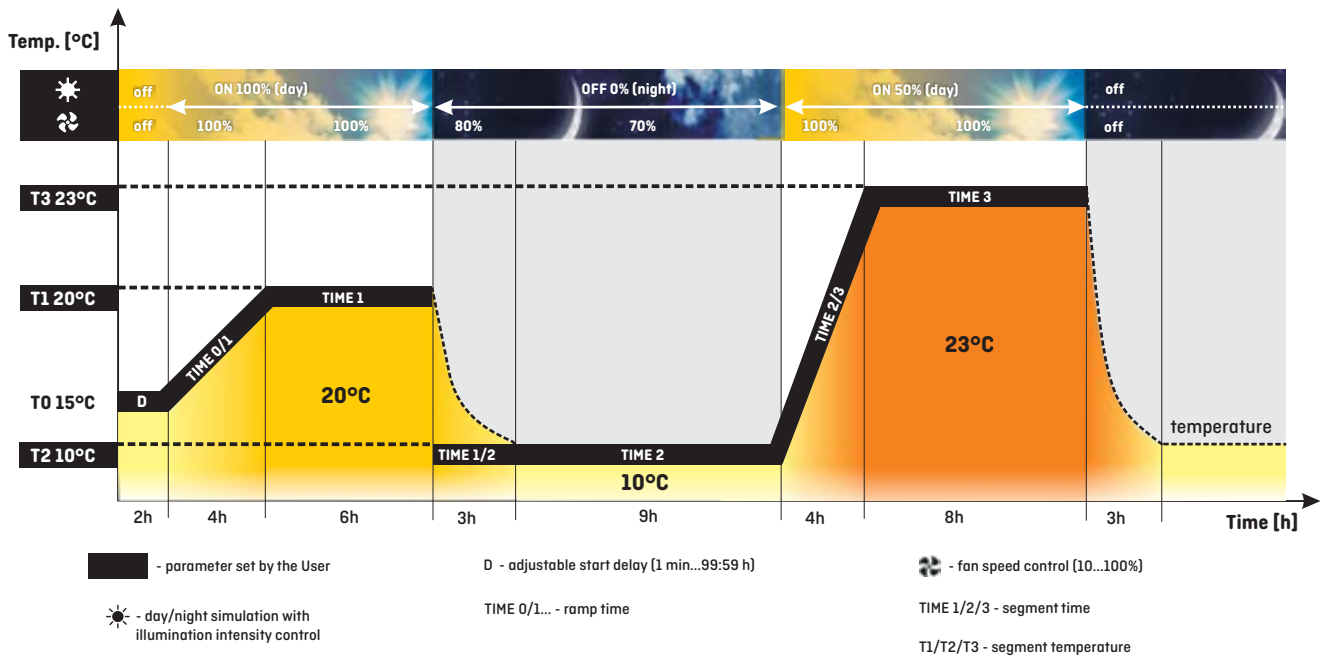

Phytotron system (* /FIT option) for cooled incubators in TOP+ version.

	IL/115/FIT P	IL/240/FIT P	IL/400/FIT P	IL/750/FIT P
temperature range with phytotron ON [°C]	+10 ... +50°C			
number of over-shelf panels with illumination std/max	1/1	1/2	1/2	1/3
adjustable illumination intensity	yes	yes	yes	yes

Drying ovens

Application

- thermal resistance analysis of building materials
- electronic and electro-technical components
- tests of properties of products subjected to high temperatures
- drying of wires of papermaking machines
- drying of laboratory glass
- general aging and curing
- preheating
- digestion of proteins
- plant tissues drying
- drug metabolism
- paper drying











Drying ovens are designed to provide high temperatures up to 300°C.

Calibration



All thermostatic equipment manufactured by POL-EKO-APARATURA can be provided with Calibration Certificate issued by accredited Measurement Laboratory. Detailed information on accreditation of POL-EKO Laboratorium Pomiarowe is available on website: www.polekolab.pl.

	SL 15	SL 32	SL 53	SL 115	SL 180	SL 240	SL 400	SL 750	SL 1000	
Parameter										
air convection	natural (SLN) / forced (SLW)						forced (SLW)			
chamber capacity ¹ [l]	15	32	56	112	180	245	424	749	1005	
door type	solid			solid/door with viewing window (option)						
temperature range	+5°C above ambient temperature ...+300°C									
temperature resolution [°C]	every 0,1									
controller	microprocessor with external LCD graphic display									
interior	acid-proof stainless steel to DIN 1.4301									
housing	-	powder coated sheet								
	INOX/G	stainless steel linen finish								
overall dims ² [mm]	A width	510	590	590	650	650	810	1010	1260	1260
	B height	550	630	700	850	1030	1200	1430	1600	2000
	C depth	440	500	600	700	760	760	750	850	850
internal dims [mm]	D width	320	400	400	460	470	600	800	1040	1040
	E height	230	320	390	540	720	800	1040	1200	1610
	F depth	200	250	360	450	560	510	510	600	600
max shelf workload ³ [kg]	-	10	10	25	25	25	25	25	-	-
	PW ⁴ version	-	-	50	50	50	100	100	100	100
max unit workload [kg]	-	20	30	40	60	75	90	120	140	-
	W ⁴ version	-	-	80	120	120	300	300	300	300
nominal power [W]	600	1100	1600	2400	2400	3000	3900	5400	5400	
weight [kg]	27	35	50	65	94	126	174	260	330	
over temperature protection	class 2.0 according to DIN 12880 / class 3.1 (option) / 3.1 in TOP+									
power supply*	230 V 50 Hz						400 3/N			
shelves fitted/max	1/2	1/3	2/5	2/7	3/9	3/10	3/14	5/16	6/22	
warranty	24 months									
manufacturer	POL-EKO-APARATURA									

all the above technical data refer to standard units (without optional accessories)

* - 230V 60Hz, 115V 60Hz also available

- 1 - working capacity of chamber can be smaller
- 2 - depth doesn't include 50 mm of power cable
- 3 - reinforced shelf
- 4 - reinforced version
- 5 - on uniformly loaded surface

All data on temperature stability and uniformity available on www.pol-eko.eu.

Options and accessories (icon description see pages 80-81)

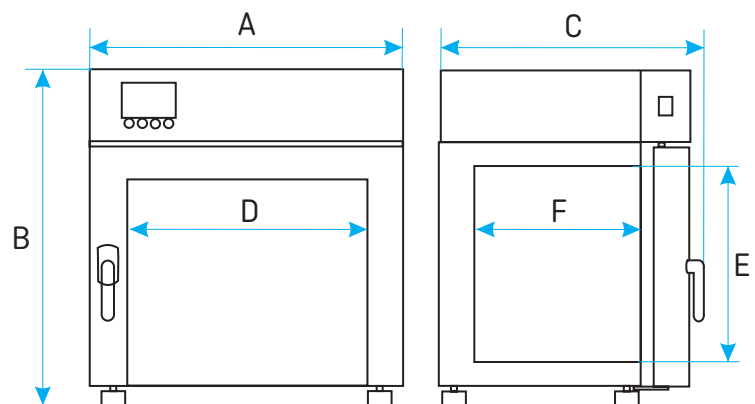
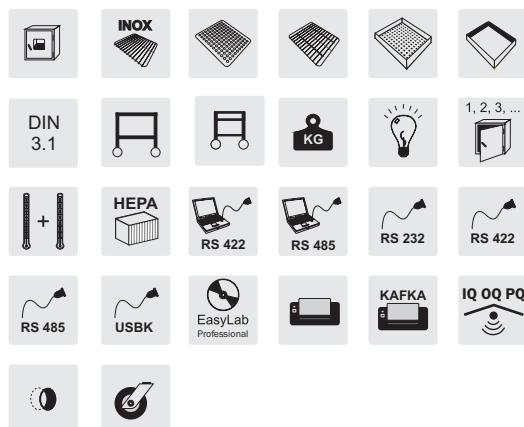

Drying ovens with nitrogen blow

The European norm ISO 589:2003 Hard Coal - Determination of Total Moisture ensures samples are dried between 105°C - 110°C in a drying oven featuring nitrogen blow possibility with flow equal to about 15x capacity of the oven per hour.

Available models

- SLWN1 - laboratory oven with dry nitrogen blow system of the chamber; the kit includes connections, valves and a laboratory rotameter (which can be calibrated)
- SLWN2 - laboratory oven with dry nitrogen blow system of the chamber; the kit includes connections, valves and a tech rotameter (which cannot be calibrated)

The nitrogen bottle is not supplied.

	SLWN1 53 SLWN2 53	SLWN1 115 SLWN2 115	SLWN1 240 SLWN2 240
chamber capacity ¹ [l]	56	112	245

1 - working capacity of chamber can be smaller

For dimensions see page 52 (models SLW 53, 115, 240)



Calibration

- Calibration in air in 9 points (corners + geometrical center) of the chamber at 1 selected by the Customer temperature in accredited laboratory. Calibration is confirmed by 'Calibration certificate'.
- Calibration in nitrogen in 9 points (corners + geometrical center) of the chamber at 1 selected by the Customer temperature in accredited laboratory. Calibration is confirmed by 'Calibration certificate'.
- Calibration of laboratory rotameter in 3 points temperature in accredited laboratory. Calibration is confirmed by 'Calibration certificate'.

SIMPLE drying oven

Simple in operation laboratory drying oven – convenient unit for customers who do not require advanced programming. Easy to use operation is based on a simple controller which allows to program temperature and time.



Standard features



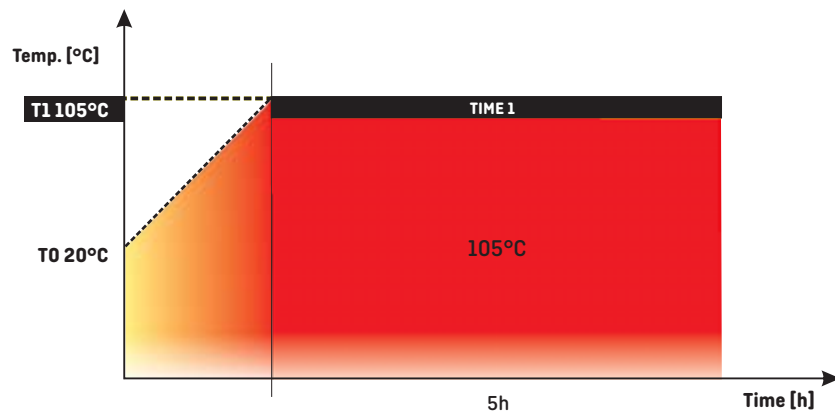

- temperature range: +5°C above ambient temperature... +250°C
- quality control protocol (at+105°C)
- English instruction manual
- temperature protection 1.0 class to DIN 12880
- access port: Ø30 mm, right side
- stainless steel shelves
- solid door

Controller advantages

- adjustment temperature
- adjustable time 0-72h, or continuous operating



■ - parameter set by User T1 - segment temperature TIME 1 - segment time

		SLN 53 SIMPLE	SLW 53 SIMPLE	SLN 115 SIMPLE	SLW 115 SIMPLE
Parameter					
air convection		natural	forced	natural	forced
chamber capacity [l]		56	56	112	112
door type		solid			
temperature range		5°C above ambient temperature +250°C			
temperature resolution [°C]		every 0,1			
controller		microprocessor with external LCD graphic display			
interior		stainless steel to DIN 1.4016			
housing		powder coated sheet			
overall dims ¹ [mm]	A width	660	660	720	720
	B height	590	590	730	730
	C depth	600	600	710	710
internal dims [mm]	D width	390	390	460	460
	E height	400	400	540	540
	F depth	360	360	450	450
max shelf workload [kg]		10	10	10	10
max unit workload [kg]		40	40	60	60
nominal power [W]		1600	1600	2400	2400
weight [kg]		50	50	65	65
over temperature protection		class 1.0 to DIN 12880			
power supply*		230 V 50 Hz			
shelves fitted/max		2/5	2/5	2/7	2/7
warranty		24 months			
manufacturer		POL-EKO-APARATURA			

all the above technical data refer to standard units (without optional accessories)

* 230V 60Hz, 3P 230V 60Hz also available

1 - depth doesn't include 50 mm of power cable

All data on temperature stability and uniformity available on www.pol-eko.eu.

Options and accessories (icon description see pages 80-81)

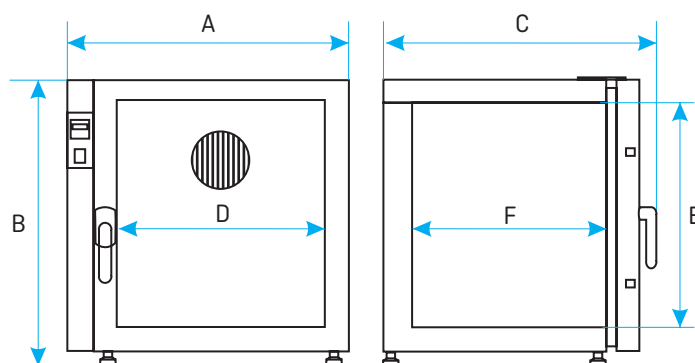

Pass-through drying ovens

Application

- drying of painted and lacquered components
- drying/sterilizing of components between clean and dirty zones
- drying of components on production line

NEW
pass through sterilizers
SRWP coming soon!



Standard and optional accessories are the same like for the SL range. Other capacities on request.

SLWP 115

SLWP 240



Parameter		SLWP 115	SLWP 240
air convection		forced	
chamber capacity ¹ [l]		112	245
door type		solid /door with viewing window (option)	
temperature range [°C]		5°C above ambient temperature ...+300°C	
temperature resolution [°C]		every 0,1	
controller		microprocessor with external LCD graphic display	
interior		acid-proof stainless steel to DIN 1.4301	
housing	-	powder coated sheet	
	INOX/G	stainless steel linen finish	
overall dims ² [mm]	width	680	820
	height	900	1160
	depth	700	770
internal dims [mm]	width	460	600
	height	530	800
	depth	460	510
max shelf workload ⁵ [kg]	-	10	10
	PW ³ version	50	100
max unit workload [kg]	-	60	90
	W ⁴ version	120	300
nominal power [W]		2400	3000
weight [kg]		65	126
over temperature protection		class 2.0 to DIN 12880 / class 3.1 (option)	
power supply*		230 V 50 Hz	
shelves fitted/max		2/7	3/10
warranty		24 months	
manufacturer		POL-EKO-APARATURA	

all the above technical data refer to standard units (without optional accessories)

* 230V 60Hz, 3P 230V 60Hz also available

1 - working capacity of chamber can be smaller

2 - depth doesn't include 50 mm of power cable

3 - reinforced shelf

4 - reinforced version

5 - on uniformly loaded surface

All data on temperature stability and uniformity available on www.pol-eko.eu.

Sterilizers

Application

- drying of laboratory glass
- hot-air sterilization

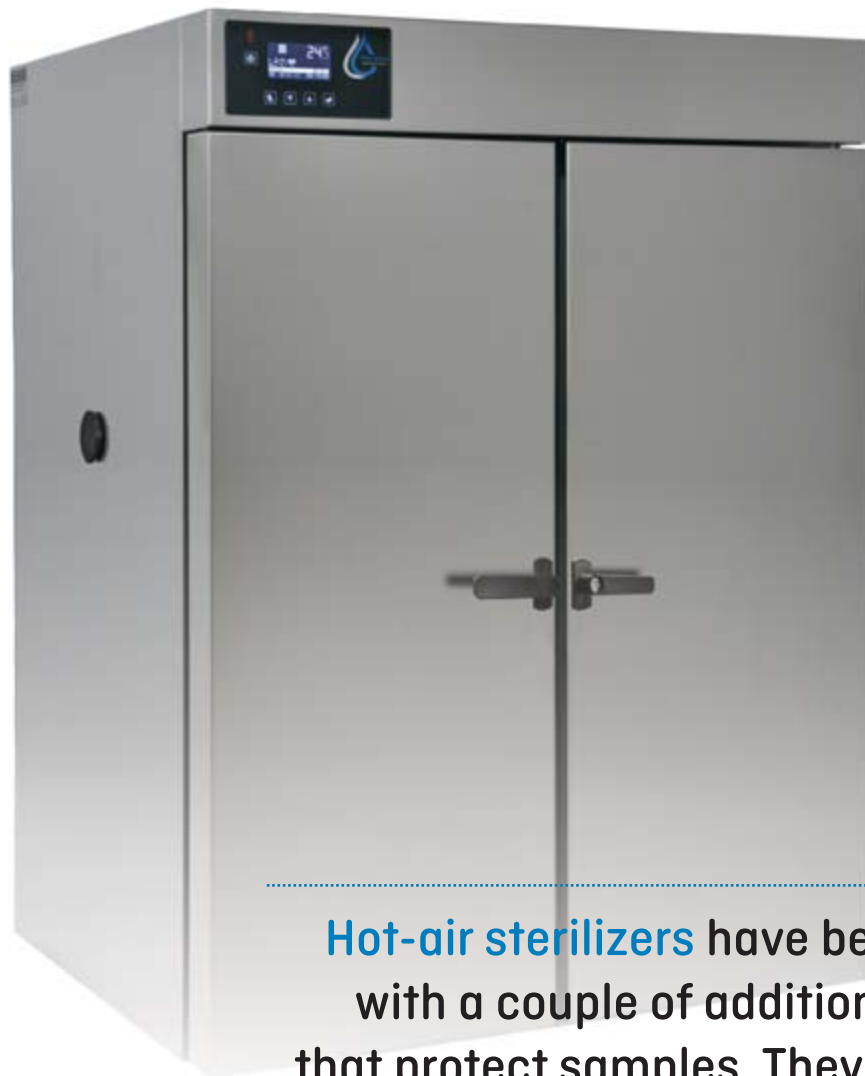

Hot-air sterilizers have been equipped with a couple of additional functions that protect samples. They can sterilize at temperatures of up to 250°C.

Calibration



All thermostatic equipment manufactured by POL-EKO-APARATURA can be provided with Calibration Certificate issued by accredited Measurement Laboratory. Detailed information on accreditation of POL-EKO Laboratorium Pomiarowe is available on website: www.polekolab.pl.

Sterilizers are equipped with the following features:

- factory preset sterilizing programs
- door locked automatically while sterilizing
- air-flap closed automatically after launching the program
- 20 user programs memory

Sterilizers are available in the STD version only.

Parameter		SR 53	SR 115	SR 240	SR 400	SR 750	SR 1000
	air convection		natural (SRN) / forced (SRW)			forced (SRW)	
chamber capacity ¹ [l]		56	112	245	424	749	1005
door type		solid / door with viewing window (option)					
temperature range		5°C above ambient temperature ...+250°C					
temperature resolution [°C]		every 0,1					
controller		microprocessor with external LCD graphic display					
interior		acid-proof stainless steel to DIN 1.4301					
housing	-	powder coated sheet					
	INOX/G	stainless steel linen finish					
overall dims ² [mm]	A width	590	650	810	1010	1260	1260
	B height	700	850	1200	1430	1600	2000
	C depth	600	700	760	750	850	850
internal dims [mm]	D width	400	460	600	800	1040	1040
	E height	390	540	800	1040	1200	1610
	F depth	360	450	510	510	600	600
max shelf workload ⁴ [kg]	-	25	25	25	25	-	-
	PW ³ version	50	50	100	100	100	100
max unit workload [kg]		40	60	90	120	140	-
nominal power [W]		1600	2400	3000	3900	5400	5400
weight [kg]		50	65	126	174	260	330
over temperature protection		class 2.0 to DIN 12880 / class 3.1 (option)					
power supply*		230 V 50 Hz			400 3/N		
shelves fitted/max		2/5	2/7	3/10	3/14	5/16	6/22
warranty		24 months					
manufacturer		POL-EKO-APARATURA					

all the above technical data refer to standard units (without optional accessories)

* 230V 60Hz, 3P 230V 60Hz also available

1 - working capacity of chamber can be smaller

2 - depth doesn't include 50 mm of power cable

3 - reinforced shelf

4 - on uniformly loaded surface

All data on temperature stability and uniformity available on www.pol-eko.eu.

Options and accessories (icon description see pages 80-81)

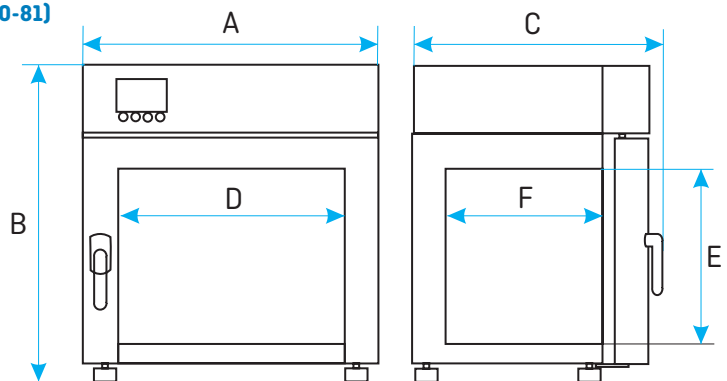

Climatic chambers

Application

- growth of plants and fungus
- seeds germination
- microorganisms and insects breeding
- photostability tests
- food preservation tests
- any kind of research that requires a stable temperature and humidity environment (optionally light)
- tests of building materials



Climatic chambers with phytotron system can control temperature, humidity and light to create a stable environment.

Calibration



All thermostatic equipment manufactured by POL-EKO-APARATURA can be provided with Calibration Certificate issued by accredited Measurement Laboratory. Detailed information on accreditation of POL-EKO Laboratorium Pomiarowe is available on website: www.polekolab.pl.

Control panel

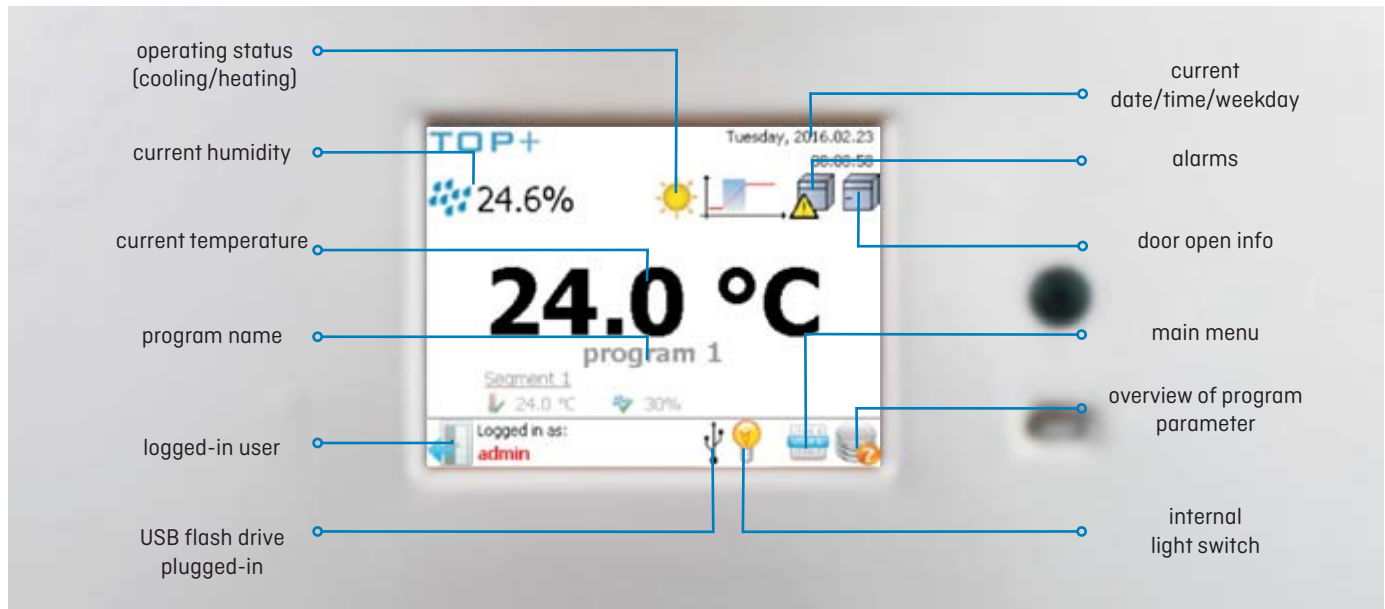

Standard features

- temperature range: -10°C ...60°C (KK) and -10...+100°C (KKS); +10°C ...+50°C (FIT option with light on)
- Ethernet cable
- TOP+ Control software
- quality control protocol (at +25°C, 60%rH)
- English instruction manual
- available menu languages: English, Estonian, French, German, Hungarian, Italian, Latvian, Polish, Portuguese, Romanian, Russian, Spanish
- temperature protection class 3.3 to DIN 12880
- open door alarm
- automatic defrosting function
- demineralised water container

RS232 interface and LAN port

access port: Ø30 mm

wire stainless steel shelves

USB port to allow direct recording and data transfer onto a flash drive

double door (external solid, internal glass)

door lock

wheels with brake

waste water container



Climatic chambers are equipped with a PID microprocessor temperature and humidity (optionally light - */FIT option) controller with a large (5,7") full colour touch screen, intuitive menu and user friendly software. They can be connected to Ethernet network for remote control from any computer, being one of their greatest advantages. Climatic chambers are available in the TOP+ version exclusively.

Controller advantages

- multi-segment temperature-time profile (up to 100)
- loop function up to 99 times or endless
- adjustable start delay feature (from 1 min to 99:59 h)
- adjustable ramps
- adjustable hold at set point time for temperature, humidity and lighting (for FIT option) from 1 min to 999:59 h, or continuous operating
- recording of min, average and max temperature and humidity value for each segment
- overview of set and current parameters while operating
- audible and visual temperature and humidity alarm
- access control via login
- Administrator function to manage User accounts
- 7 days programming
- possibility of temperature and humidity calibration by the User
- operating in temperature or time priority mode
- temperature and humidity sensor fail alarm
- power failure control system (program continued after restoring power)
- real time clock
- digital timer
- auto-diagnostic function
- forced air convection with fan speed control from 10 up to 100%
- automatic fan shut-down after completing the program

GLP supporting functions:

- password protected settings
- 20 user programs memory
- internal memory to store up to 4100 data records for each User, possibility to overview the values on the display or a PC computer in tabular or graphic form
- USB port to allow direct data recording or transfer onto a flash drive
- events registry

TOP+ control application included (see page 68).

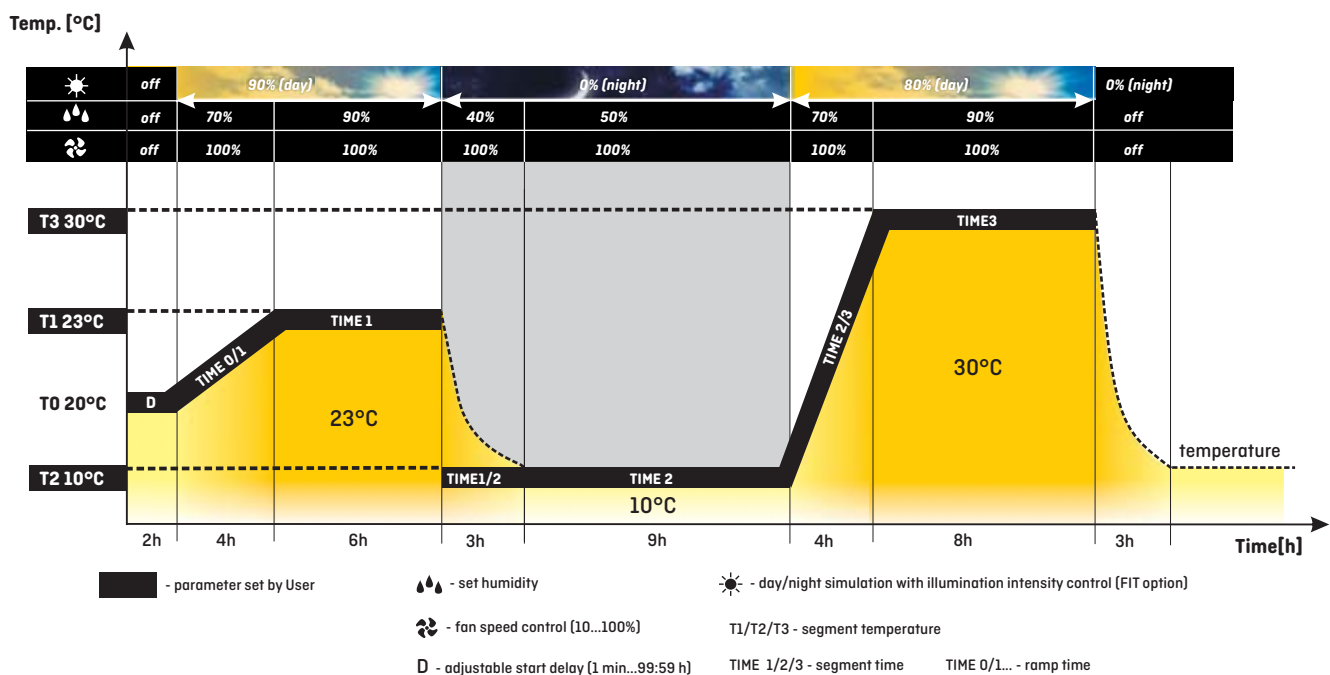

▲ Climatic chambers with phytotron system (* /FIT option)

- temperature, humidity and light control
- day/night simulation with light intensity control:
 - lamps in the door and side walls KK 350, 500 and 700 FIT DS
 - lamps in the side walls KK 350, KK 500 and 700 FIT S
 - lamps in the door KK 115 and KK 750 FIT D
 - lamps in the over-shelf panels KK 115, 240, 400, 500, 700, 750, 1200, 1450 FIT/P (and FIT PANEL)
- temperature range with light OFF: -10°C up to 60°C
- temperature range with light ON: +10°C up to +50°C
- light colour selection
- max light intensity 15000 LUX per panel (measured 25cm under the light source)



FIT D - Climatic chambers with lamps installed in the door

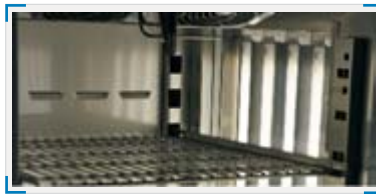

FIT S - Climatic chambers with lamps installed in the side walls



FIT DS - Climatic chambers with lamps installed in the door and side walls

Climatic chambers equipped with phytotron system can control temperature and humidity, as well as light intensity to simulate day and night conditions. Standard light colour is 840 type and the tubes can be installed in the door, side walls or over-shelf panels.

There are also special LED panels designed for plant growing. As most plants use only a part of the sunlight emission, narrow spectrum and specific colours have been used. A and B chlorophyll absorbance maxima are blue and red colour. Chlorophyll absorbs most energy and strongly influences photosynthesis at blue colour spectrum which intensifies growth. Red and far red colours (619-720nm wave length) stimulate blooming and proliferation.

	KK 115	KK 240	KK 350	KK 400	KK 500	KK 700	KK 750	KK 1200	KK 1450
FIT P	+	+		+	+	+	+	+	+
FIT D	+						+		
FIT S					+	+			
FIT DS			+		+	+			

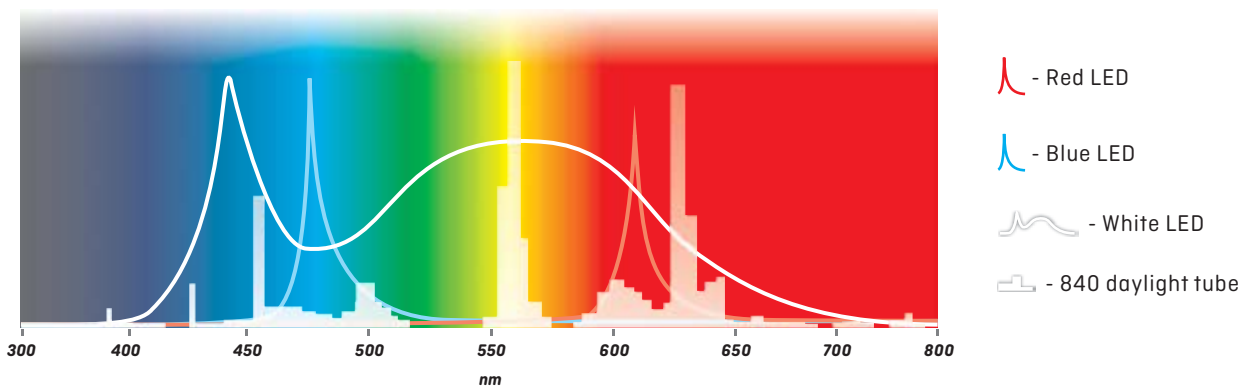



FIT P-version



FIT P LED -version



LED White -version

Available light tubes:

- standard type 840 for daylight simulation
- UV tubes for air sterilization and food aging tests

840 daylight type intensity:

- 280 $\mu\text{mol}/\text{m}^2\text{s}$ (25cm below light source)

Available LED modules:

- deep red – max for wave length 660 nm
- blue – max for wave length 470 nm
- far red – max for wave length 740 nm
- white – max for wave length 440 nm

LED light intensity:

for configuration of multiple: 2 modules of far red and 1 blue

- 50 cm below light source – 165 [$\mu\text{mol}/\text{m}^2\text{s}$]
- 25 cm below light source – 230 [$\mu\text{mol}/\text{m}^2\text{s}$]

for configuration of multiple: 3 modules of white LED

- 50 cm below light source – 135 [$\mu\text{mol}/\text{m}^2\text{s}$]
- 25 cm below light source – 190 [$\mu\text{mol}/\text{m}^2\text{s}$]

FIT P version

Climatic chambers with over-shelf panels with light. Depending on the model, there can be between 1 and 3 panels inside the chamber (standard light colour: 840 daylight). The FIT P version includes 1 over-shelf panel and sockets to allow installation of extra panels if required (to be ordered separately). The **FIT/R3** option allows to control the light intensity separately for each panel.

KK 115 KK 240 KK 400 KK 500 KK 700 KK 750 KK 1200 KK 1450



		KK 115	KK 240	KK 400	KK 500	KK 700	KK 750	KK 1200	KK 1450
standard		1	1	1	1	1	1	1	1
max*		1	2	2	3	3	3	3	3
max light intensity on shelf	FIT version	5000	10000	15000	15000	15000	15000	15000	15000

*max number of over-shelf, panels with illumination inside the chamber

FIT P LED version

The user can choose the light colour and intensity for each program segment. The colour modules can be combined, e.g. far red with blue. Dimming allows to set the required level of intensity. This flexibility provides specific light selection for each plant. The LED modules are long-life – after 25000 operating hours they still feature 90% of the nominal efficiency. The unique optics ensures uniform light distribution for each plant. The LED technology also emits very little heat which helps maintain precise temperature inside the chamber.

Climatic chambers with ultrasonic humidifier are professional and reliable equipment to guarantee stable and precise conditions. The max temperature of 60°C allows to use them for seed germination, fungus and plant growing or food tests. Perfect climatic conditions allow stability tests of pharmaceuticals and cosmetics, as well as packaging and electronics.

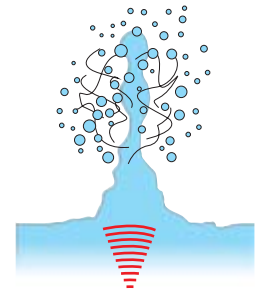

The ultrasonic humidifier uses piezo-electric generators which convert electrical energy into mechanical vibrations energy. The generators are immersed in deionized water and smash it into very small drops which are consequently sprayed uniformly inside the chamber.

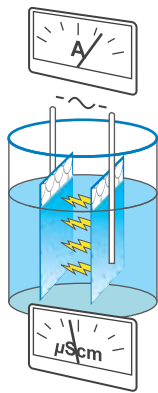

The KKS climatic chambers with steam humidifier do not emit ultrasounds and therefore allow insects breeding (e.g. *Drosophila melanogaster*). Compared to the KK chambers, they feature an extended temperature and humidity range and can be used for tests of electronics, plastic or building materials.

The steam humidifier consists of a two-electrode boiler immersed in tap water. The voltage applied to electrodes generates a flow of electric charge between them in the water. According to Joule's first law, the electrical energy dissipates which rises the temperature. As soon as water starts boiling, a stream of steam is generated which next comes into the chamber.

The KK and KKS climatic chambers can be used for pharmaceutical stability tests according to **ICH Q1A**

Parameter		Climatic chamber KK with ultrasonic humidifier	Climatic chamber KKS with steam humidifier
Temperature range	-	-10 °C... +60 °C	-10 °C... +100 °C
	FIT	-10 °C... +60 °C (+10 °C...+50 °C with light on)	
Relative humidity range		field "A"	field "A+B"
Water supply (conductivity)		deionized [≤1 µS/cm]	tap water [125-1250 µS/cm]
Water source		<ul style="list-style-type: none"> ● deionized water container ● deioniser ● internal deionized water network 	<ul style="list-style-type: none"> ● water supply system ● tap water container

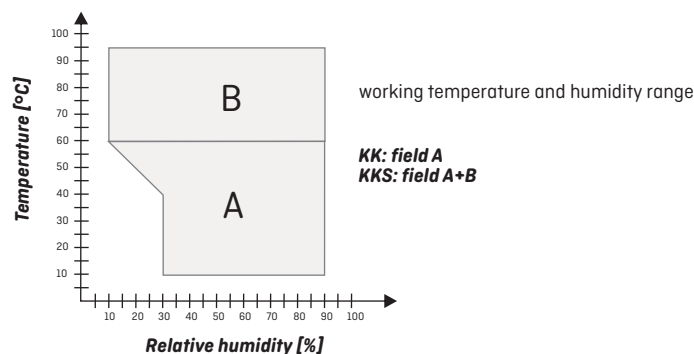

Climatic chambers with ultrasonic humidifier

		KK 115	KK 240	KK 350	KK 400	KK 500	KK 700	KK 750	KK 1200	KK 1450
air convection		forced								
chamber capacity [l]		112	245	335	424	493	625	749	1365	1467
working capacity [l]		112	245	335	424	386	450	749	1229	1307
door type		double (external solid, internal glass) / external glass (option)								
temperature range [°C]	-	-10...+60								
	FIT version	-10...+60°C (with light on +10...+50°C)								
temperature resolution [°C]		every 0,1								
relative humidity range [%]		30...90 (see working temperature and humidity chart for details on page 64)								
humidity resolution [%]		every 1								
controller		microprocessor with external LCD graphic display								
interior		acid-proof stainless steel to DIN 1.4301								
housing	-	powder coated sheet								
	INOX/G	stainless steel linen finish								
overall dims ¹ [mm]	A width	650	810	640	1020	630	730	1250	1460	1440
	B height	1160	1600	2000	1840	1990	2000	2000	1990	1970
	C depth	960	1000	980	1000	1040	1070	1100	1070	1170
internal dims [mm]	D width	460	600	500	800	510	600	1040	1310	1340
	D' width	-	-	-	-	510	600	-	1310	1340
	E height	540	800	1340	1040	1510	1510	1200	1510	1460
	F depth	450	510	500	510	640	690	600	690	750
	I height	-	-	1270	-	1380	1360	-	1360	1300
max shelf workload ² [kg]	-	10	10	10	10	20	30	-	30	30
	PW ³ version	50	100	100	100	100	100	100	100	100
max unit workload [kg]		60	90	100	120	100	150	140	300	300
nominal power [W]	-	1000	1500	1400	2000	1600	1600	2500	2200	2200
	FIT version	1200	1800	2600	2300	2000	2000	2900	3000	3000
weight [kg]		90	140	125	185	130	170	275	220	230
over temperature protection		class 3.3 to DIN 12880								
power supply*		230 V 50 Hz								
shelves fitted/max		2/7	3/10	3/11	3/14	3/11	3/11	5/16	2 x 3/11	2 x 3/11
warranty		24 months								
manufacturer		POL-EKO-APARATURA								

all the above technical data refer to standard units (without optional accessories)

* - 230V 60Hz, 115V 60Hz also available

1 - external dimensions for units without FIT option, depth doesn't include 50 mm of power cable

2 - on uniformly loaded surface

3 - reinforced shelf

All data on temperature stability and uniformity available on www.pol-eko.eu.

Options and accessories (icon description see pages 80-81)



Climatic chambers with steam humidifier

		KKS 115	KKS 240	KKS 400	KKS 750
air convection		forced			
chamber capacity [l]		112	245	424	749
working capacity [l]		112	245	424	749
door type		double (external solid, internal glass) / external glass (option)			
temperature range [°C]	-	-10...+100			
	FIT version	-10...+60°C (with light on +10...+50°C)			
temperature resolution [°C]		every 0,1			
relative humidity range [%]		10...90 (see working temperature and humidity chart for details on page 64)			
humidity resolution [%]		every 1			
controller		microprocessor with external LCD graphic display			
interior		acid-proof stainless steel to DIN 1.4301			
housing	-	powder coated sheet			
	INOX/G	stainless steel linen finish			
overall dims ¹ [mm]	A width	650	810	1020	1250
	B height	1160	1600	1840	2000
	C depth	960	1000	1000	1100
internal dims [mm]	D width	460	600	800	1040
	E height	540	800	1040	1200
	F depth	450	510	510	600
max shelf workload ² [kg]	-	10	10	10	-
	PW ³ version	50	100	100	100
max unit workload [kg]		60	90	120	140
nominal power [W]	-	2000	2200	3475	4165
	FIT version	2050	2520	3625	4325
weight [kg]		103	140	185	275
over temperature protection		class 3.3 to DIN 12880			
power supply*		230V 50Hz			
shelves fitted/max		2/7	3/10	3/14	5/16
warranty		24 months			
manufacturer		POL-EKO-APARATURA			

all the above technical data refer to standard units (without optional accessories)

* - 230V 60Hz, 115V 60Hz also available

1 - external dimensions for units without FIT option, depth doesn't include 50 mm of power cable

2 - on uniformly loaded surface

3 - reinforced shelf

All data on temperature stability and uniformity available on www.pol-eko.eu.

Options and accessories (icon description see pages 80-81)



KK/KKS 115/240/400/750

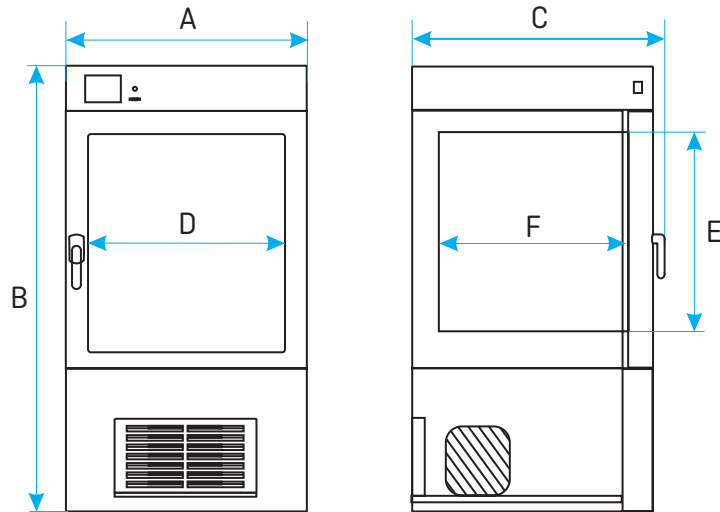

KK 350

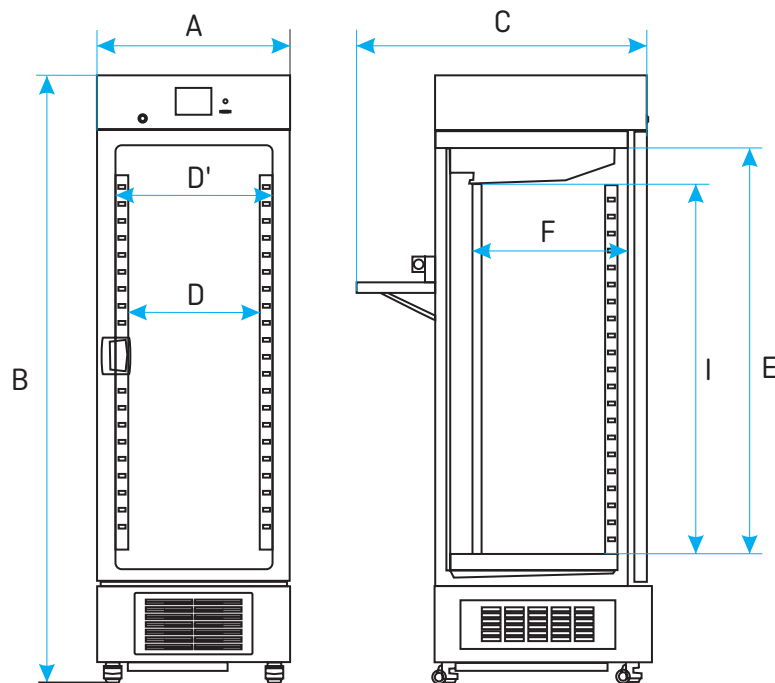

KK 500/700/1200/1450

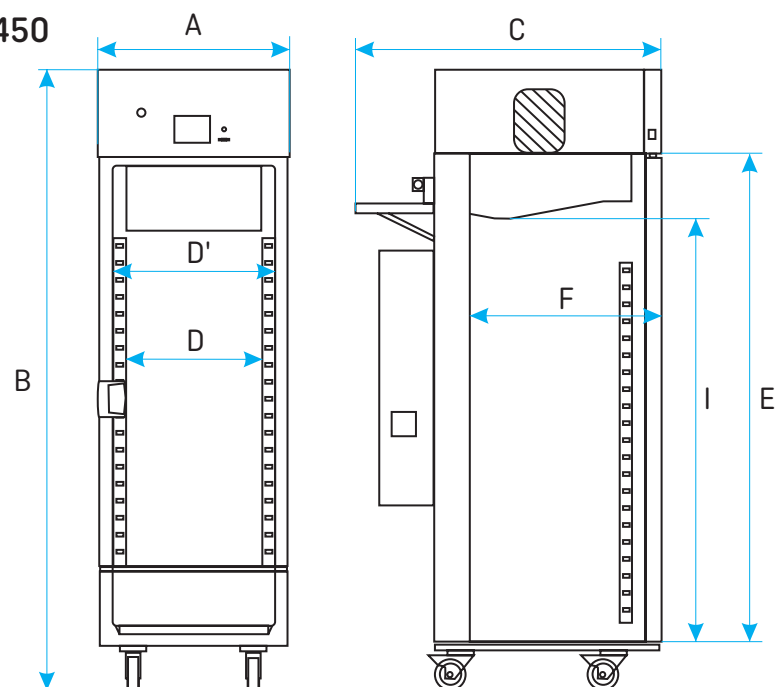

Software

EasyLab Basic

Using EasyLab Basic software the User can easily download data saved in the unit's internal memory to the PC. Basic version of EasyLab is available free of charge (download from the website www.polekolab.com). In order to keep constant data registration to the PC, create charts or statistical reports, EasyLab Professional version must be purchased.



Downloaded data

TOP+ Control software

To facilitate the configuration of complex programs, a TOP+ Control software has been introduced. Moreover, the User is able to program and control the "TOP+" equipment with ease from any corner of the world by accessing the unit via Internet!



Device status

EasyLab Professional

EasyLab Professional software features temperature and humidity monitoring in all thermostatic equipment manufactured by POL-EKO-APARATURA.

The User may record constant or temporary values, accumulate them and convert into charts. RS 232 or USB port allows the recording process (it is necessary to purchase a connection cable along with the software). If the unit is equipped with an additional Pt100 temperature sensor, the EasyLab Professional software enables simultaneous recording. Additionally EasyLab Professional software enables programming of devices in TOP+ version, thanks to integrated TOP+ Control application.

EasyLab Professional features high quality tools for chart making and approximation.

Standard features of EasyLab Professional software:

- report creator data
- import from external memories
- multilanguage (English, Estonian, French, German, Hungarian, Latvian, Polish, Portuguese, Romanian, Russian, Spanish).



Statistical report



02

Thermostatic equipment options and accessories parameters description



Internal glass door

This is standard equipment in CL/IL/KK ranges.
This is an additional option available for ST/CHL ranges.
Order number: */C (option factory preinstalled).



External glass door

This is an additional option available for ST/CHL ranges
and for KK 500, 700, 1200, 1450 models.
Order number: */A (option factory preinstalled).



Door with viewing window

This is an additional option available for CL/IL/SL/SR ranges
(except CL/SL 15, 32) and for KK 115, 240, 400, 750 models.
Order number: */A (option factory preinstalled).
In case of SL range, maximum temperature is reduced to
+250°C.



Internal socket

This is an additional option available for ST/CHL/CL/IL/KK
ranges. In case of CL/IL maximum temperature is reduced to
+70°C.
Order number: GNZ (option factory preinstalled).
Internal socket allows to plug in additional equipment inside the
chamber, e.g. laboratory shaker.
Max socket peak load 200 W.



Interior lighting

This is standard equipment in ST/CHL ranges.
This is an additional option available for all products.
Order number: OWW (option factory preinstalled).
Interior lighting features 1 light point. The user switches it
on with enter button located in the front panel.
This option does not allow day/night simulation (see FIT and
FOT options). Max working temperature of the unit is reduced to
+70°C, for SL/SR ranges to +250°C.

Wire shelf

This is standard equipment in ST/CHL BASIC models.
This is an additional option available for ST/CHL BASIC models.

Order number: */P.

Wire shelf is made of steel and covered with plastic.
It is provided with slides set.



Perforated shelf

This is standard equipment in ZLW-T models.
This is an additional option available for ST/CHL/CL/IL/SL/SR/KK ranges and ZLN 85 model.

Order number: */PP.

Perforated shelf is provided with slides set.
Different depths of the shelf on request.



Full shelf with hole

This is standard equipment in ZLN-T models.

Order number: */P0.

shelf is provided with slides set.



Stainless steel wire shelf INOX

This is standard equipment in CL/IL/SL/SR/KK ranges,
ZLN 85 model and in ST/CHL COMF and PREM models.

This is an additional option for mentioned above products.

Order number: */P INOX.

INOX wire shelf is made of stainless steel.
It is provided with slides set.



Reinforced shelf

This is standard equipment in CL/IL/SL 750 and 1000 models and all CL/IL/SL models in the reinforced version (order number: */W). This is an additional option available for CL/IL/SL/SR/ST/CHL/KK ranges and ZLN-T models.

Order number: */PW.

Reinforced shelf is provided with slides set.
Maximum shelf workloads and maximum unit workloads can be found in the tables with parameters for certain product ranges.



Reinforced version



This is standard feature of CL/SL 1000 models. This is an additional option available for CL/IL/SL ranges and ZLN-T 200, 300 models. Order number: */W [option factory preinstalled]. Reinforced version of products allows to store heavy loads in the chamber. It consists of reinforced construction of the chamber and reinforced shelves. In this way we prevent damage to the unit caused by heavy loads. Maximum shelf workloads and maximum unit workloads can be found in the tables with parameters for certain product ranges. When a unit in reinforced version is purchased, the reinforced shelves are supplied instead of wire shelves.



Aluminum drawer with powder coated slides

This is an additional option available for ST/CHL ranges. **Order number: ST/CHL SWP ALU.** The drawer is aluminum, 6 cm deep, provided with pull out powder coated slides set, with 2 compartments longways + 2 across in each section.

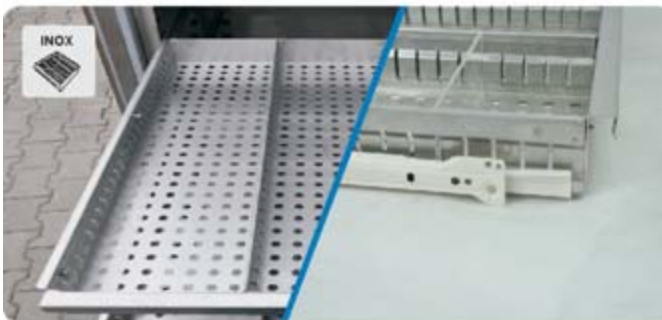

Stainless steel drawer with powder coated slides

This is an additional option available for ST/CHL ranges. **Order number: ST/CHL SWP INOX.** The drawer is stainless steel, 6 cm deep, provided with pull out powder coated slides set, with 2 compartments longways + 2 across in each section.



Stainless steel drawer with stainless steel slides

This is an additional option available for ST/CHL ranges. **Order number: ST/CHL SWPN INOX.** The drawer is stainless steel, 6 cm deep, provided with pull out stainless steel slides set, with 2 compartments longways + 2 across in each section.



Pharma organizer

This is an additional option for ST/CHL 2/3/4/5/6. Consists of 4 drawers. **Order number: ORG-FARM**

Stainless steel cuvettes

This is an additional option available for all products ranges.

Order number: KUW.

Stainless steel cuvettes can be placed on the shelves.

Different sizes available.



Photoperiodic system

This is an additional option for the ST BASIC, COMF, PREM models and IL STD version.

Order number: */FOT (option factory preinstalled).

Photoperiodic system allows day and night simulation.

See pages 19 and 49 for more details.



Phytotron system

This is an additional option for the KK range, IL TOP+ version and ST 500-1450 PREM TOP+ models

Order number: */FIT (option factory preinstalled).

Phytotron system allows day and night simulation with smooth illumination control (each 1%)

See pages 20, 50 and 62-63 for more details.



Additional Pt 100 temperature sensor

This is an additional option available for CL/IL/SL/SR/KK ranges and ST/CHL PREM TOP+ version.

Order number: Pt 100 (option factory preinstalled).

This option consists of an additional temperature sensor and sensor's socket. Additional Pt 100 values are visible in the display. Additional Pt 100 sensor also allows to choose in the unit's menu which sensor should be used as primary and which as secondary. This way unit can work according to the sample temperature in which additional Pt 100 sensor is placed.

The sensor may be supplied with a calibration certificate.



Wheels

This is standard equipment in ZLN-T 300, ST/CHL 1200, 1450; CL/IL/SL/SR 750, 1000; IL 400; and KK range.

This is an additional option available for all product ranges.

Order number: QLK*(option factory preinstalled).





EasyLab Professional software

This is an additional option available for all product ranges.

Order number: EasyLab Professional.

All the thermostatic products manufactured by POL-EKO-APARATURA are equipped with an RS232 interface and USB port and can be connected to a PC.

The EasyLab Professional software allows to record temperature and/or humidity values. The data (day, time, temperature/humidity values) can be transferred to a PC and displayed in a tabular form which can be also used to generate charts and statistical reports. It can be further stored or exported to the .xls format.

See page 68 for more details.



Dot printer

This is an additional option available for all product ranges.

Order number: EPSON.

DOT printer enables current temperature, time and date printing. Printing interval is to be set in the unit's menu. It is necessary to purchase RSK (PC and printer connection cable).



Thermal printer

This is an additional option available for all product ranges.

Order number: KAFKA.

Thermal printer enables current temperature, time and date printing. Printing interval is to be set in the unit's menu. It is necessary to purchase RSK (PC and printer connection cable).



HEPA-fresh air filter

This is an additional option available for CL/SL/SR ranges.

Order number: HEPA (option factory preinstalled).

HEPA filter is installed at the air inlet to the chamber.



Table with wheels

This is an additional option available for ST/CHL 1-3; ZLN 85, CL/SL 15, 32; CL/IL/SL/SR 53-240 models.

Order number: */S (powder painted) or */S INOX (stainless steel).

Table with wheels provides you with the highest comfort of using our products. We offer a wide range of tables equipped with wheels.

Different sizes of the tables are available on request.

The user can choose the most suitable height.

Base on castors

This is an additional option for ST/CHL 1, 2, 3;
ZLN 85, CL/SL 15, 32; CL/IL/SL/SR 53, 115, 240.

Order number: */ST, */ST INOX

Height and dimensions can be customized.



RS 232 cable/ RS 422/ RS 485

This is an additional option available for all product ranges.

Order number: RSK.

RS 232 cable is a connection cable for PC or printer.

RS 422 is a connection cable for PC.

This cable is indispensable in order to connect PC to the unit equipped with RS 485 interface

Standard cable length: 5m.



USB cable

This is an additional option available for all product ranges except TOP+ version.

Order number: USBK.

This cable is indispensable in order to connect PC to the unit via USB port. Standard cable length: 5m.



RS 422 interface / RS 485 interface

These are additional options available for all product ranges.

Order number: RS422 or RS485 (option factory preinstalled).

This option consists of a converter from RS 232 (standard built in the device) to RS 422 or RS 485.

It allows to plug a few pieces of equipment in-line to PC.



Container for waste water

This is standard equipment in KK range.

This is an additional option available for KK range.

Order number: KK/K.

This is a plastic container for waste water coming from the chamber. The container is indispensable when it is not possible to connect the unit directly to a drain system.





Container for deionised water

This is standard equipment in KK range.
This is an additional option available for KK range.

Order number: KK/Z.

This plastic container is for deionised water which is indispensable for a proper KK performance.
The container is not necessary in case the chamber is plugged directly to a deionizer.



Low water level sensor

This is an additional option available for KK range.
Order number: KK/CP (option factory preinstalled).

An alarm goes off when the water level is low.



Chart recorder

This is an additional option available for ST/CHL 500, 700, 1200, 1450 models.

Order number: */RK (option factory preinstalled).

Built in chart recorder with constant temperature registration is equipped with battery back-up, therefore it keeps temperature registration even in case of power shortage. It comes with 100 pieces of registration papers as a start kit.



Magnetic door lock

This is an additional option available for ST/CHL 500, 700, 1200, 1450 models.

Order number: */ZKM (option factory preinstalled).

Magnetic door lock comes with the set of access cards – 5 pcs.
RFID card reader enables quick access to the chamber (the reader must be touched with the card in order to open the door).
The access is reserved only for authorized Users (card holders).



FIT panels independent control

This is an additional option available for the units equipped with FIT option – at least two (2) over-shelf illumination panels.

Order number: FIT/R3 (option factory preinstalled).

This option consists in possibility to control each of 2 or 3 over-shelf illumination panels (their intensity) independently (e.g. one panel intensity can be set at 100%, the other one at 50%).



Automatic defrosting function

This is standard feature of KK range.

This is an additional option available for ST/CHL/IL ranges.

Order number: * PLUS (option factory preinstalled).

Defrosting in this case is programmable (the User sets periodicity and duration). This function is carried out while the unit is working. This advanced technology holds the temperature stable, allowing only a minor increase in the chamber (considerably higher temperature rise is caused by opening the door).



Extended temperature range ST/70

This is standard feature of ST PREM TOP+ models. This is an additional option available for ST BASIC, COMF and PREM version.

Order number: ST/70 (option factory preinstalled).

It consists of extended temperature range up to +70°C (standard temperature range in ST BASIC, COMF and PREM: +3°C...+40°C).



Low temperature version

This is an additional option available for CHL 500, 700, 1200 models and IL range.

Order number: */T (option factory preinstalled).

It extends temperature range down to -10°C (standard temperature range starts from 0°C).



Calibration of the chamber

This is an additional option available for all product ranges.

Order numbers: BRT/9/L, BRT/1P/L, BRT/2P/L, IQ, OQ, PQ (option factory preinstalled).

This option consist of measurements performed at 9 points of the chamber (corners + geometric center) or at 5 points on the shelf (corners + geometric center) at the temperature selected by the User.

IQ, OQ, PQ qualification is available for each chamber as well (see page 10 for more details).



Humidity measurement

This is an additional option available for CL/IL/KK ranges and ST/CHL PREM TOP+ models.

Order number: PHR (option factory preinstalled).

This option is not humidity control but humidity measurement. The user can browse humidity values in the unit's display.



Fan speed control

This is standard feature of ST/CHL PREM TOP+

This is an additional option available for ST/CHL BASIC, COMF, PREM models.

Order number: ST/CHL WENT (option factory preinstalled).

It allows to control the fan speed in the range of 50% to 100%. Different fan speed can be set for each program segment separately.



Door openings counter

This is an additional option available for all product ranges.

Order number: LOD (option factory preinstalled).

This function counts door openings (how many times the door was opened during the program cycle).



Non-standard access port

This is an additional option available for all product ranges.

Order number: OCZ/N (option factory preinstalled).

Diameter and location on request.

Over temperature protection class 1.0 and class 2.0 according to DIN 12880

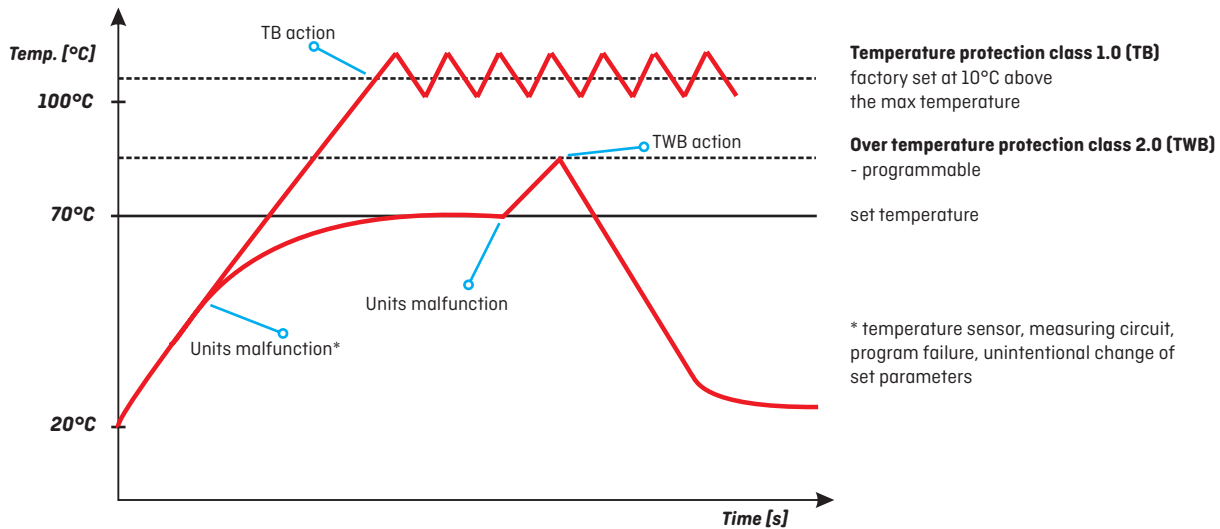

Over temperature protection class 1.0 to DIN 12880 is a standard function for the ST/CHL/CL/IL/SL/SR/KK equipment. It is factory set at approx. 10°C above the max temperature. Over temperature protection class 2.0 to DIN 12880 is a standard function for the CL/IL/SL/SR equipment in the STD version and ST/CHL PREM models. It features a sample protection function: the User can set the protection temperature and once it has been exceeded, the program will cut off the heaters. To resume operating, the User has to switch the unit off and turn it on again.

DIN 3.1

Over temperature protection class 3.1 according to DIN 12880

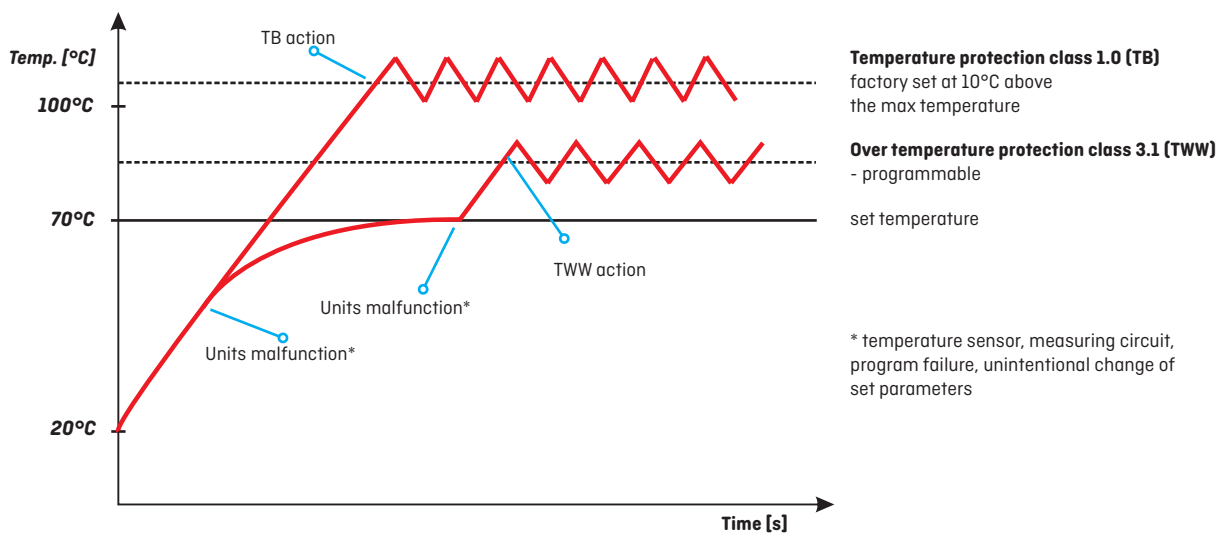

Over temperature protection class 3.1 to DIN 12880 is a standard function for the CL/SL equipment in the TOP+ version, and optional for the CL/SL/SR ranges in the STD version.

Order number: */3.1 (option factory preinstalled).

It features a sample protection function: the User can set the protection temperature and once it has been exceeded, the program will cut off the heaters. When the temperature falls down below the set limit, the unit will resume operating automatically.

DIN 3.2

Under temperature protection class 3.2 according to DIN 12880

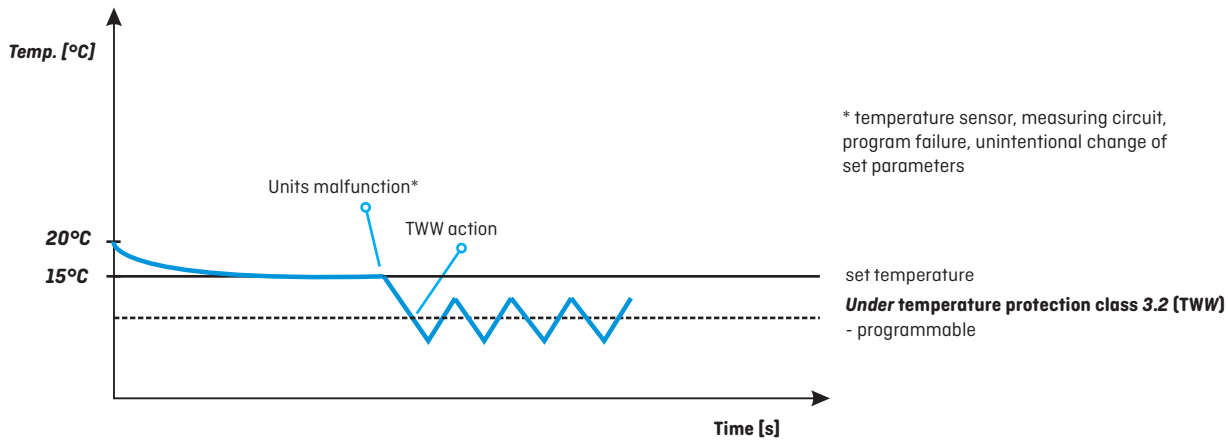

Under temperature protection class 3.2 to DIN 12880 is a standard function for CHL PREM TOP+ version and optional for CHL BASIC, COMF, PREM; ZL COMF and PREM models.

Order number: */3.2 (option factory preinstalled).

It features a sample protection function: the user can set the protection temperature and once it has been exceeded, the program will cut off the compressor. When the temperature goes above the set limit, the unit will resume operating automatically.

DIN 3.3

Over/under temperature protection class 3.3 according to DIN 12880

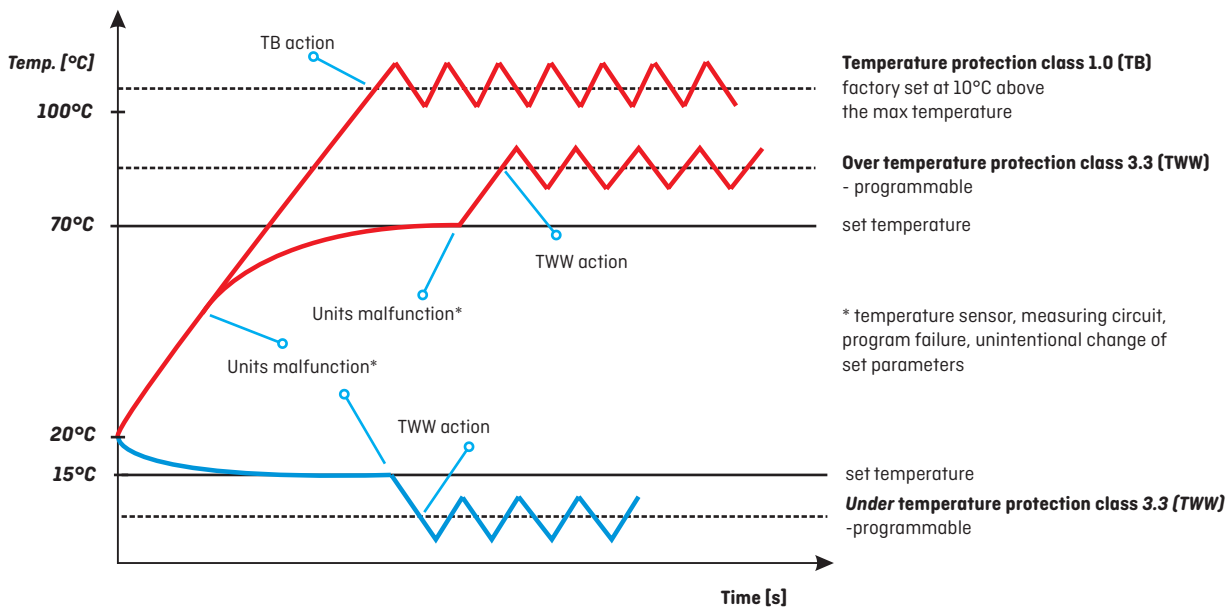

















































Over/under temperature protection class 3.3 to DIN 12880 is a standard function for the KK, ST PREM TOP+ and IL in the TOP+ version. It is an additional option for ST BASIC, COMF, PREM and IL in the STD version.

Order number: */3.3 (option factory preinstalled).

It features a sample protection function: the User can set the over/under protection temperature and once it has been exceeded, the program will cut off the heaters or compressor. When the temperature goes back to the permitted range, the unit will resume operating automatically.

Options and accessories

	ST		CHL		ZL	CL		IL		SL		SR	KK
	P	TOP+	P	TOP+	P	STD	TOP+	STD	TOP+	STD	TOP+	STD	TOP+
 Internal glass door Order number: */C	✓	✓	✓	✓	-	S	S	S	S	-	-	-	S
 External glass door Order number: */A	✓	✓	✓	✓	-	-	-	-	-	-	-	-	✓
 Door with viewing window Order number: */A	-	-	-	-	-	✓	✓	✓	✓	✓	✓	✓	✓
 Wire shelf Order number: */P	✓	-	✓	-	-	-	-	-	-	-	-	-	-
 INOX Stainless steel wire shelf Order number: */P INOX	✓	✓	✓	✓	✓	✓	✓	✓	✓	✓	✓	✓	✓
 Perforated shelf Order number: */PP	✓	✓	✓	✓	✓	✓	✓	✓	✓	✓	✓	✓	✓
 Full shelf with hole Order number: */PO	-	-	-	-	✓	-	-	-	-	-	-	-	-
 Reinforced shelf Order number: */PW	✓	✓	✓	✓	✓	✓	✓	✓	✓	✓	✓	✓	✓
 Stainless steel cuvettes Order number: KUV GN*/*	✓	✓	✓	✓	✓	✓	✓	✓	✓	✓	✓	✓	✓
 ALU Aluminum drawer with powder coated slides Order number: ST/CHL/SWP ALU	✓	✓	✓	✓	-	-	-	-	-	-	-	-	-
 INOX Stainless steel drawer with powder coated slides Order number: ST/CHL/SWP INOX	✓	✓	✓	✓	-	-	-	-	-	-	-	-	-
 INOX/INOX Stainless steel drawer with stainless steel slides Order number: ST/CHL/SWP INOX	✓	✓	✓	✓	-	-	-	-	-	-	-	-	-
 Pharma organizer Order number: ORG-FARM	✓	✓	✓	✓	-	-	-	-	-	-	-	-	-
 Wheels Order number: QLK*	✓	✓	✓	✓	✓	✓	✓	✓	✓	✓	✓	✓	S
 Table with wheels Order number: */S or */S INOX	✓	✓	✓	✓	✓	✓	✓	✓	✓	✓	✓	✓	✓
 Base on castors Order number: */ST or */ST INOX	✓	✓	✓	✓	✓	✓	✓	✓	✓	✓	✓	✓	✓
 Automatic defrosting function Order number: *PLUS	✓	✓	✓	✓	-	-	-	✓	✓	-	-	-	S
 Low temperature version Order number: */T	-	-	✓	✓	-	-	-	✓	✓	-	-	-	-
 Extended temperature range to 70°C Order number: ST/70	✓	S	-	-	-	-	-	-	-	-	-	-	-
 KG Reinforced version Order number: */W	-	-	-	-	✓	✓	✓	✓	✓	✓	✓	✓	-
 Interior lighting Order number: OWW/LED	S	S	S	S	✓	✓	✓	✓	✓	✓	✓	✓	-
 Fan speed control Order number: ST/CHLWENT 50...100%	✓	S	✓	S	-	S	S	S	S	S	S	S	S
 Phytotron system Order number: */FIT	-	✓	-	-	-	-	-	-	✓	-	-	-	✓
 Photoperiodic system Order number: */FOT	✓	-	-	-	-	-	-	✓	-	-	-	-	-
 90% 30% FIT panels independent control Order number: FIT/R3	-	✓	-	-	-	-	-	-	✓	-	-	-	✓
 1, 2, 3, ... Door opening counter Order number: LOD	✓	✓	✓	✓	✓	✓	✓	✓	✓	✓	✓	✓	✓

	ST		CHL		ZL	CL		IL		SL		SR	KK
	P	TOP+	P	TOP+	P	STD	TOP+	STD	TOP+	STD	TOP+	STD	TOP+
 Additional temperature sensor Order number: PT 100	-	✓	-	✓	-	✓	✓	✓	✓	✓	✓	✓	✓
 Internal socket Order number: GNZ	✓	✓	✓	✓	-	✓	✓	✓	✓	-	-	-	-
 HEPA - fresh air filter Order number: HEPA	-	-	-	-	-	✓	✓	-	-	✓	✓	✓	-
 Humidity measurement Order number: PHR	-	✓	-	✓	-	✓	✓	✓	✓	-	-	-	✓
 Non-standard access port for external sensor Order number: OCZ/N	✓	✓	✓	✓	✓	✓	✓	✓	✓	✓	✓	✓	✓
 Container for deionized water Order number: KK/Z	-	-	-	-	-	-	-	-	-	-	-	-	✓
 Container for waste water Order number: KK/K	-	-	-	-	-	-	-	-	-	-	-	-	✓
 Low water level sensor Order number: KK/CP	-	-	-	-	-	-	-	-	-	-	-	-	✓
 RS 422 interface (instead of RS 232) Order number: RS422	✓	✓	✓	✓	✓	✓	✓	✓	✓	✓	✓	✓	✓
 RS 485 interface (instead of RS 232) Order number: RS485	✓	✓	✓	✓	✓	✓	✓	✓	✓	✓	✓	✓	✓
 RS 232 cable Order number: RSK	✓	✓	✓	✓	✓	✓	✓	✓	✓	✓	✓	✓	✓
 RS 422 cable Order number: RSK/422	✓	✓	✓	✓	✓	✓	✓	✓	✓	✓	✓	✓	✓
 RS 485 cable Order number: RSK/485	✓	✓	✓	✓	✓	✓	✓	✓	✓	✓	✓	✓	✓
 USB cable Order number: USBK	✓	-	✓	-	✓	✓	-	✓	-	✓	-	✓	-
 Dot printer Order number: EPSON	✓	✓	✓	✓	✓	✓	✓	✓	✓	✓	✓	✓	✓
 "Kafka" thermal printer Order number: KAFKA	✓	✓	✓	✓	✓	✓	✓	✓	✓	✓	✓	✓	✓
 EasyLab - Professional software Order number: EasyLab Professional	✓	✓	✓	✓	✓	✓	✓	✓	✓	✓	✓	✓	✓
 Calibration and IQ, OQ, PQ qualification Order number: BRT/* /L or IQ/OQ/PQ	✓	✓	✓	✓	✓	✓	✓	✓	✓	✓	✓	✓	✓
 Over temperature protection 3.1 class according to DIN 12880 Order number: */3.1	-	-	-	-	-	✓	S	-	-	✓	S	✓	-
 Over temperature protection 3.2 class according to DIN 12880 Order number: */3.2	-	-	✓	S	✓	-	-	-	-	-	-	-	-
 Over temperature protection 3.3 class according to DIN 12880 Order number: */3.3	✓	S	-	-	-	-	-	✓	S	-	-	-	S
 Chart recorder Order number: */RK	✓	✓	✓	✓	-	-	-	-	-	-	-	-	-
 Magnetic door lock Order number: ZKM	✓	✓	✓	✓	-	-	-	-	-	-	-	-	-

✓ - available

- - unavailable

S - standard equipment**P** - BASIC, COMFORT, PREMIUM

Defrosting function

Defrosting is performed automatically but it has to be launched manually by the user at the most suitable time (e.g. when there are no samples in the chamber). It consists in a temperature increase in the chamber by about 20-30°C, therefore it cannot be turned on during regular work (so not to disturb temperature stability in the chamber).

Over/under temperature (and humidity in KK) sound alarm

It is possible to set temperature (and humidity in KK) offset in the program menu. If the temperature or humidity exceeds or falls beyond the set point, the alarm will go off and the "ALARM" message will appear on the display.

Temperature (and humidity in KK) sensor fail alarm

If the sensors are not working correctly, an error message appears on the display.

Sound alarm

This function sounds the alarm at a time specified by the user.

E-mail info

This is standard feature of all products in TOP+ version. It consists of e-mail notifications about set temperature (and humidity in KK) values exceeding on max 2 e-mail addresses. Internet connection is necessary in order to use this feature.

Ethernet connection and remote control via Internet

This is standard feature of all products in TOP+ version. The units can be both controlled and monitored via Internet. It is also possible to connect several units at the same time and control them from one PC.

Test results memory

All the products except SL SIMPLE ovens are equipped with test results memory. It features memory module that allows to store 2046 data records (in case of TOP+ version: 4100 for each User) and send it to a PC at any time (EasyLab Basic, TOP+ Control or EasyLab Professional software are necessary along with RSK or USBK cables).

Access port for external sensor

All the products are equipped with standard access port. It is placed in the left side of the chamber (in case of SL SIMPLE – in the right). Different dimension and location of the access port on request.

Door lock

All the products except SL SIMPLE ovens are equipped with the door lock.

Temperature program priority

Equipment which feature temperature program priority work according to the following rule: the unit achieves set temperature first and then starts time countdown. In this case primary parameter is temperature.

Time program priority

Equipment which feature time program priority work according to the following rule: the unit starts the process of achieving set temperature simultaneously with time being countdown. In this case primary parameter is time.

Power failure control system

A temporary power failure while running the program is unnoticeable due to autoresume function but the time of power shortage is displayed on the screen.

Administrator function

This is standard feature of all products in TOP+ version. It allows to manage user accounts and supports GLP.

7 days programming

This is standard feature of all products in TOP+ version. It allows user to set independent program for each day of the week (e.g. Monday, 9.00-15.00, at 37°C).

Open door alarm

All the products are equipped with an open door alarm. After the door is being opened the alarm goes off (sound alarm and message appears on the display) according to the set by the User alarm delay.

RS 232 interface / USB port (N/A TOP+)

All the products are equipped with RS 232 and USB ports. This feature enables on-going data transmit to the PC and its registration, e.g. temperature and/or humidity values. For this reason, it is necessary to purchase a connection cable (RSK or USBK) and EasyLab Professional software. Only TOP+ version products feature direct USB flash drive data saving facility.

Temperature (and humidity in KK) calibration

This is standard feature of all products in TOP+ version and CL/IL/SL in STD version. Thanks to this feature the User has got a possibility to calibrate the temperature (and humidity in KK).



03

**Other laboratory
equipment**

Other laboratory equipment

\ <i>RT 2014 data logger</i>	85
\ <i>Thermostatic boxes</i>	88
\ <i>Colony counter</i>	89
\ <i>Laboratory shakers</i>	90
\ <i>Stationary samplers</i>	92



RT 2014 data logger

The new generation of RT data loggers enables continuous measurement of temperature and/or humidity values in thermostatic equipment (thermostatic chambers, incubators, refrigerators, freezers, etc...), as well as in the air. In case of temperature increases beyond acceptable range (set by the User) or in case of power failures, the RT 2014 logger can send SMS notifications to selected phone numbers.

The following notifications are available:

- alarm on temperature fluctuations (high/low) with possibility of alarm notification delay
- alarm on 230V power shortage with possibility of alarm notification delay
- automatic reports at certain time of the day or on request

▲ Data logger models

RT 2014_1T - temperature or humidity data logger with GSM, single channel model dedicated for temperature or humidity measurements in the thermostatic chamber (single channel for one Pt 100 sensor or for one humidity sensor); internal memory (stored data can be downloaded to PC with EasyLab Professional software); GSM (sends SMS alarms for 2 phone numbers).

RT 2014_2T - temperature and/or humidity data logger with GSM module, double channel model dedicated for temperature and/or humidity measurements in the thermostatic chamber (double channel for two Pt 100 sensors or one Pt 100 and one humidity sensor); internal memory (stored data can be downloaded to PC with EasyLab Professional software); GSM (sends SMS alarms for 2 phone numbers)

RT 2014_1T_WIFI - temperature or humidity data logger with Wi-Fi single channel model dedicated for temperature or humidity measurements in the thermostatic chamber (single channel for one Pt 100 sensor or for one humidity sensor); internal memory (stored data can be downloaded to PC with EasyLab Professional software);

RT 2014_2T_WIFI - temperature or humidity data logger with Wi-Fi, double channel model dedicated for temperature or humidity measurements in the thermostatic chamber (double channel for two Pt 100 sensors or one Pt 100 and one humidity sensor); internal memory (stored data can be downloaded to PC with EasyLab Professional software);

▲ Accessories

Model	Photo	Description	Measuring range	Cable length
PT 100 H		temperature sensor for RT 2014 data logger, for high temperatures (recommended for CL/SL)	temp.: 0...+400°C	length 2,5 m
PT 100 S		standard temperature sensor for RT 2014 data logger (recommended for ST/CHL/IL/KK)	temp.: -40...+180°C	length 2,5 m
PT 100 L		temperature sensor for RT 2014 data logger, for low temperatures (recommended for ZL)	temp.: -110...+120°C	length 2,5 m
RH_STD		humidity and temperature sensor for RT 2014 data logger (recommended for ST/IL)	rH: 0...80% temp.: 0...60°C	length 2,5 m
RH_PREM		humidity and temperature sensor for RT 2014 data logger (recommended for KK)	rH: 0...100% temp.: -50...100°C	length 2,5 m
HP	-	internal pressure sensor	-	-
EasyLab Professional		software, see pages 68 for more details	-	-
FIT		fitting	-	-

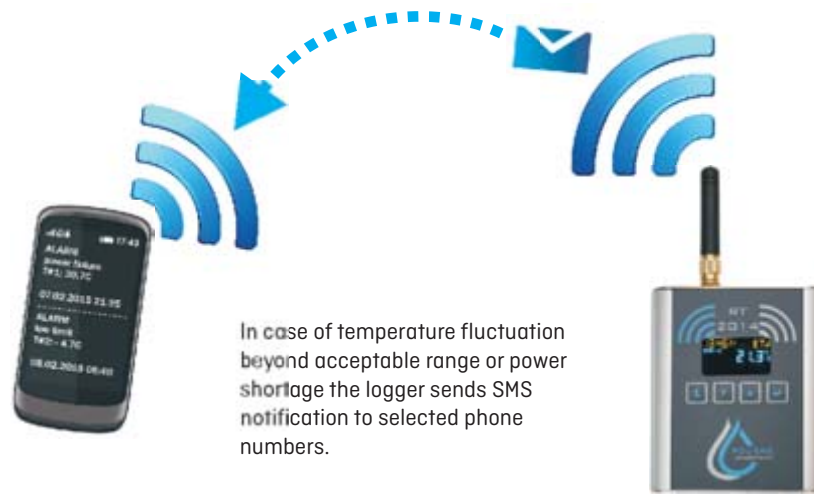

In case of temperature fluctuation beyond acceptable range or power shortage the logger sends SMS notification to selected phone numbers.

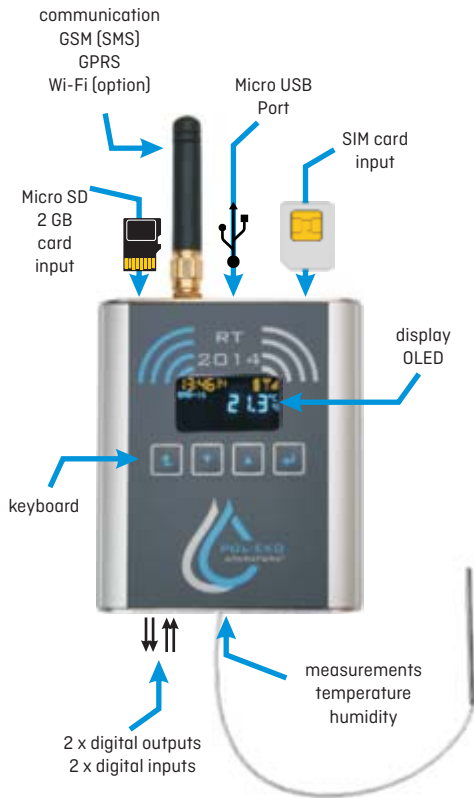

RT 2014*



Parameter

temperature measurement	2 x external Pt 100
temperature measurement range (according to sensor) [°C]	-110 ... +400
temperature measurement range (according to sensor) [°F]	-166 ... +752
resolution / accuracy of temperature measurement [°C]	0,1 / +/- 0,2
humidity measurement	external SHT / HygroClip
humidity measurement range [%]	SHT: 0-80; HygroClip 0-100
resolution / accuracy of humidity measurement [%]	1% / SHT: 1,8; HygroClip 0,8
air pressure measurement	internal - piezo-resistant
pressure measurement range [hPa]	300 - 1100
resolution / accuracy of pressure measurement [hPa]	1 / 1,5
length of sensors cables [m]	2,5
real time clock	yes
data record interval [min]	1/5/15/30/60
internal memory	1 mln data measurements
additional (external) memory	Micro SD 2 GB card
interface	Micro USB
power supply	5 VDC via USB port
battery life	48 hours
display	OLED 128x64 px
overall dims (HxWxD) [mm]	85 x 72 x 20
weight [g]	165
GSM frequency	4 ranges
quantity of phone numbers for SMS notification	5
warranty	24 months
manufacturer	POL-EKO-APARATURA

* parameters for fully equipped model

Calibration



All thermostatic equipment manufactured by POL-EKO-APARATURA can be provided with Calibration Certificate issued by accredited Measurement Laboratory. Detailed information on accreditation of POL-EKO Laboratorium Pomiarowe is available on website: www.polekolab.pl.

RT 2014 GSM & Wi-Fi operating diagram

RT 2014 monitoring system complies with requirements of Sanitary-Epidemiological Stations on vaccines storage conditions.

All available alarms ensure safe and proper storage of significant value vaccines in refrigerators. Temperature fluctuations beyond acceptable range not only can cause financial losses, but also health and life threat for people who undergo vaccinations.

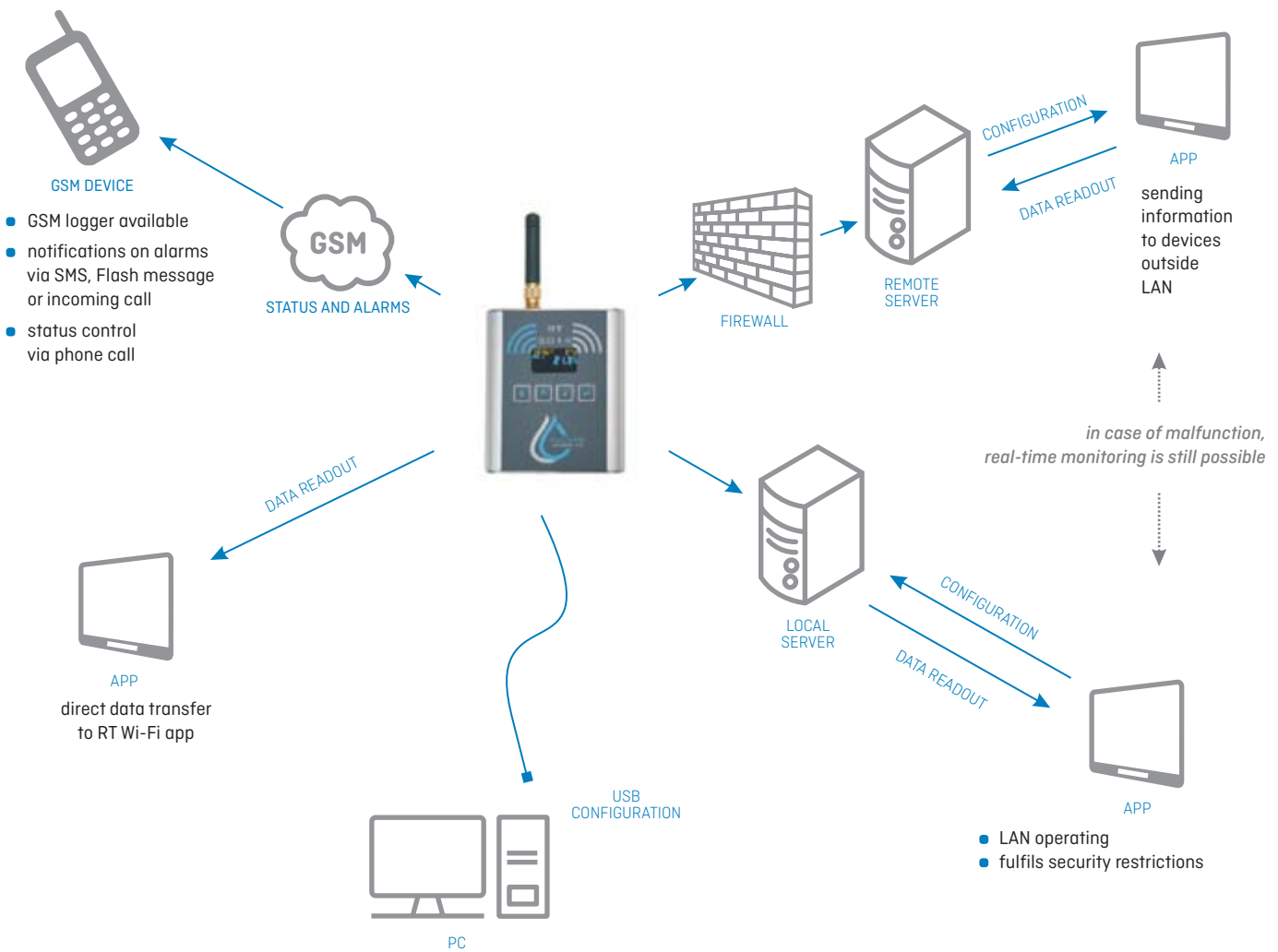

RT 2014 app allows communication between data logger and smartphone (available for download in Google Play)



go to website

Thermostatic boxes

Advantages

- chamber capacity from 27 to 106 litres
- transport in stable temperature, e.g. +4°C
- adjustable temperature from -18 to +10°C
- stable temperature regardless of ambient conditions
- temperature display
- battery, car socket (not for TB 80A and TB 105A) or standard mains power supply
- wireless temperature data loggers available (option)

Application

- transport of:
- water and sewage samples
 - biological substances, tissues etc.
 - blood and haematoid material according to certain directives

The TB boxes, compared to normal car fridges, ensure stable temperatures for samples during transport. They can also be used as a portable mini-refrigerators thanks to the internal battery.







chamber with bottles for samples

wide range of wireless temperature data loggers is available



Options and accessories



		TB 32 A	TB 50 A	TB 80 A	TB 105 A
					
Parameter					
chamber capacity [l]		27	42	80	106
temperature range [°C]		-18...+10			
temperature resolution [°C]		every 1,0			
interior		powder coated aluminum			
housing		plastic			
overall dims [mm]	width	690	725	790	790
	height	410	470	455	555
	depth	400	455	500	500
internal dims [mm]	width	320	340	500	500
	height	320	370	365	465
	depth	290	330	400	400
nominal power [W]		43	52	65	65
weight [kg]		18	22	45	50
voltage [V]		100-240 AC 50/60 Hz or 12 DC			
warranty		12 months			
manufacturer		POL-EKO-APARATURA			

Colony counter

Advantages

- automatic weight compensation of Petri plates
- anti-shock counting technology
- ringlight technology enables even illumination of the counting field
possibility of working with bright or dark background
- mean value calculation function
- standard marker included
- optional marker ZM 2002 for external counting
- Petri plates adapters (diameter < 120 mm)
- removable Wolfhuegel scale plate
- adjustable push force
- sound and visual counting control
- adjustable position of the magnifying glass
- affordable price

Standard features

- colony counter
- magnifying glass
- standard marker
- bright and dark background
- Petri plates adapters
- Wolfhuegel scale plate

Accessories

- marker ZM 2002 for external counting



Colony counter is invaluable help in every microbiological laboratory since the most time consuming activity is counting the colonies on Petri plates. An easy-to-use unit featuring quick and precise counting.



Parameter		
counting field diameter [mm]		120
display		LED (0...999)
magnifying glass		2,5 X
illumination		20 W ringlight
dims [mm]	width x depth x height	300 x 325 x 90
weight [kg]		4,9
nominal power [W]		22
voltage 50/60 Hz [V]*		230
warranty		24 months
manufacturer		POL-EKO-APARATURA

* 115V 60Hz also available

Laboratory shakers

Advantages

- orbital movement
- microprocessor control of rotation and time
- orbital diameter: 10...25 mm
- max shaking weight: 10 kg
- variable speed control: 30...300 rpm
- shaking mode: from 1 min to 99 h, or continuous operation
- LCD digital display
- anti-skid mat (option)
- various shaking tables
- can be located inside cooled incubators

Accessories

- universal shaking table
- separating funnel attachment
- fixing clip support
- dish attachment
- test tube support
- Erlenmeyer flasks (25...2000 ml) attachment
- Anti-skid mat



Laboratory shakers have been designed to fit inside cooled incubators (IL range).



Parameter		LS 280	LS 350	LS 500	LS 700
movement		orbital			
controller		microprocessor			
display		LCD display			
speed range [rpm]		30 ... 500		30 ... 300	
accuracy [rpm]		10			
amplitude [mm]		5	5 or 10		
max load capacity [kg]		10			
shaking mode		1 min. ... 99 h or continuous operation			
dimensions without / with shaking table [mm]	width	320	390	550	700
	height	120 / 220	120 / 220	120 / 220	120 / 220
	depth	330	400	440	420
fits to cooled incubator		ILW 53	ILW 115	ILW 240	ILW 400
ambient temperature [W]		60	60	60	60
weight with shaking table [kg]		10	15	22	25
ambient temperature [°C]		+10...+40			
humidity [%]		up to 70			
voltage 50/60Hz [V]		230 V 50 Hz			
warranty		24 months			
manufacturer		POL-EKO-APARATURA			

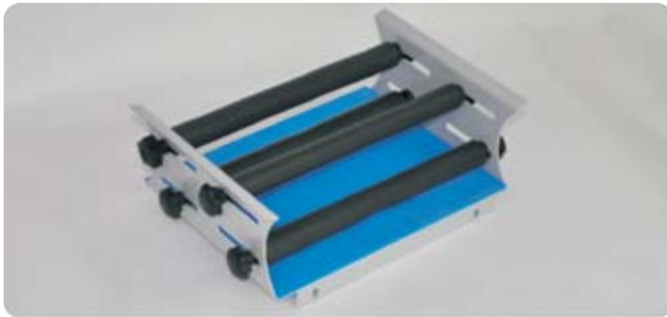

Universal platform

Universal platform for various kinds of vessels with 4 roller clamps (without anti-skid mat).



Platform for fixing flask handles

Platform for fixing flask handles, suitable for flasks of the following capacities: 25ml, 50ml, 100ml, 250ml, 500ml, the handles shall be ordered separately.



Platform for Petri plates shaking

Platform for shaking Petri plates, bacteria culture flasks and other vessels of low centre of gravity.



Platform for separatory funnels

Platform for separatory funnels with 3 roller clamps for shaking, salting, extraction and concentration.

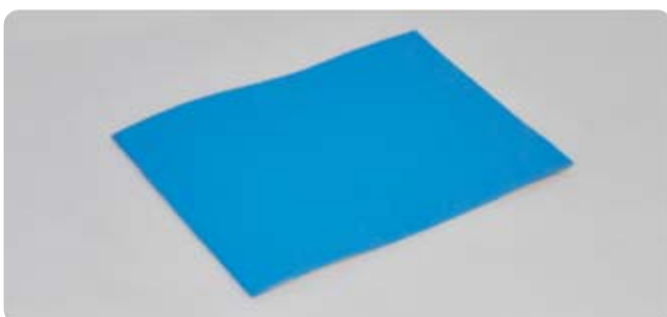

Anti-skid mat

Anti-skid mat for LS laboratory shakers.

Stationary samplers

Advantages

- representative sample taking according to PN-ISO 5667
- sampling system:
 - vacuum
 - peristaltic pump
- sampling mode:
 - time proportional
 - flow proportional
 - event (e.g.: pH value exceeding)
 - combined
- intuitive menu
- up to 5 configurable sampling programs
- bottle filling overview
- suitable for continuous outdoor use
- can be implemented into a monitoring system
- refrigerated chamber
- SD card recording system: pH, conductivity, redox, dissolved oxygen, flow, chamber temperature etc.
- sampler viewer program (for samplers equipped with SD card)



Representative sample taking according to PN-ISO 5667 directive.

Parameter	PP 2002+	PP 2002E	PP 2002M
sampling system	vacuum system	peristaltic pump	peristaltic pump / vacuum system
sample storing	stable temperature +4°C regardless of ambient conditions		
menu language	English, French, Polish, Czech, Romanian, Lithuanian, Italian		
medium	liquid media of min conductivity 20 µS/cm and max temp. 60°C		
hose blowing	before and after sample taking		
sampling mode	automatic time proportional, flow proportional, event or manual		
sampling height [m]	max 8 / up to 30 (option)		
sample volume [ml]	regulated 30...250/500	regulated 10...9990	regulated 30...250/500 or 10...9990
hose length [m]	8 standard		
hose diameter [mm]	12/13		
distributor	round		
number of bottles x capacity [l]	24 x 1; 12 x 2,9; 4 x 10; 1 x 25		
overall dims [mm]	width	630	630
	height	1070	1325
	depth	660	660
weight [kg]	90		100
housing	acid-proof stainless steel with 40 mm insulation		
ambient temperature [°C]	-20...+45		
nominal power [W]	350		450
controller	microprocessor, graphic display		
programming	5 programs, 8 tasks each		
data logging	SD card (option)		SD card
input signals	8 analogue, 4 binary		
output signals	4 binary		
communication	RS 232 or RS 485 / PROFIBUS, modem GSM (option)		
installation site	indoor or outdoor		
voltage 50Hz [V]	230 V 50 Hz		
warranty	24 months		
manufacturer	POL-EKO-APARATURA		



04

**Laboratory furniture
Compact Lab
Fume hoods**

Compact Lab furniture

The furniture that we offer is remarkable for its mechanical resistance. It has been constructed from highest quality materials. There is a wide selection of standard frames, cupboards, panels and worktops, but customized solutions are available too.



Advantages

- steel construction based on A, C, O - type frames covered by chemically resistant epoxy paint, featuring easy leveling, plastic feet;
- possibility of realization cabinets based on pedestal, without frames
- module system – possibility of extend in the future
- wide selection of worktops
- possibility to choose height of stands: 900 mm (standing work) or 750 mm (sitting work)
- cabinets made of galvanized steel, covered by chemically resistant epoxy powder paint on light grey colour (RAL 7035 – possibility to choose different colour from RAL palette)
- various configuration of cabinets: right/left doors, drawer and door, column with drawers
- possibility to fit drawers or containers on wheels under the worktop
- wall mounted cabinets closed or opened: height 480, 630, 780 mm
- self-closing hinges and slides
- possibility to place door lock for drawers and doors
- wide range of additional accessories – chemo resistant sinks, armature, drains, eye-washers, emergency showers, top sections with different length shelves, bridges, electrical sockets, gas valves
- work safety guaranteed by compliance with PN-EN 13150 and PN-EN14727 norm
- consulting, projects and visualizations



Compliance certificate for Compact Lab furniture

Suspended bridge

Island with suspended bridge for media with various configurations of metal underbench cabinets.



Shelf with marine edges

Pull-out shelf with marine edges in metal underbench cabinet with double door and 1/2 drawer.



Cabinet on wheels

Cabinet (container) on wheels, with lock. Height 480 mm and 630 mm (without wheels), width 450 mm and 600 mm. Possible variants with single door, single door and drawer, with 3 or 4 drawers.



Pharmacy racks

Pharmacy racks with lockable cabinets. Standard shelf workload is 20kg, reinforced shelf workload is 1/2 40kg (with 1/2 20 cm cabinet width).



Steel columns with shelves

Steel columns with shelves for media: water, electricity, gas; designed for wall tables and islands.



Frames

Supporting frames made of steel profile type A, C, Ø, covered by chemically resistant epoxy paint, completed with adjustable, plastic feet with levelling and adjusting of height; possible realization of cabinets on plinths - without using frames.





Weighing table

Weighing table, the structure of which is supported on two separate frames. The first is made of powder coated sheet and is a form of aesthetic housing, on the second anti-vibration granite slab with dimensions of 400 x 400 mm is placed. Depending on the width, it may have one or two granite slabs.



Wall table

Wall table, L-shaped with the position to wash. Construction is based on C-frame type, made of high-grade steel with rectangular, closed profile. Worktop made of 20 mm phenolic resin. Under the worktop are placed underbench cabinets, including installation cabinet under sink.



Drawers with organizer

Free-standing cabinet (rack) having in the lower part drawers with organizer, equipped with silent closing system and full pull-out.



Island table

Island table with the position to wash and steel columns with shelves in which electrical sockets and water installation are installed. Laboratory fittings are covered by chemically resistant polyamide coating. Worktops and sinks are made of epoxy resin in grey colour. Under worktop are placed underbench metal cabinets with various configurations of door and drawers.



Transfer window

Transfer window with stainless steel worktop and wall hood. Solution often used in clean rooms.



Visualizations

Together with the offer, we can prepare project and visualization in 3DVIA program customized to the individual customer needs

Worktops



DURCON – worktop made of epoxy resin. This material has monolithic and ideally homogenous structure on the whole thickness. It characterizes very low permeability, high resistance on high temperature, hardness comparable with stone and without stratification or fractures. DURCON is highly resistant to most acid and other chemical compounds and used in laboratory works as well as discoloration which is the result of pigment. Available thickness: 10 or 25 mm with or without marine edge.

QUARTZ-GRANITE CONGLOMERATE – worktop made of quartz-granite conglomerate with polyester resin. This kind of worktop characterizes high mechanical resistance and smooth surface. Possibility to order also marine edge worktop. Thickness: 20 mm.



MAX RESISTANCE – laboratory worktop made of pressure laminate. It consists of hard black core (manufactured as a result of pressing of cellulose fibres in high pressure and temperature) which is covered both sided with layer of special paper and melamine resin. This material is non-flammable and does not absorb moisture. Surface is resistant on many chemical substances. Thickness: 4-20 mm.

LAMINATE – worktop made of chipboard covered on the outside with layer of HPL laminate. Because of its limited chemical and physical resistance, laminate worktops are applicable mainly as tables under apparatus, subsidiary tables or laboratory desks.

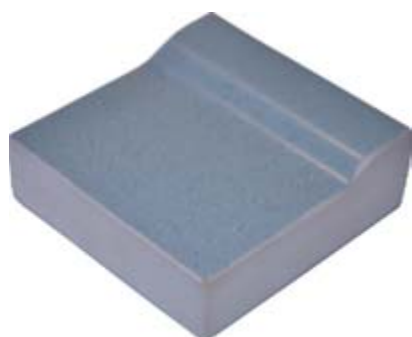
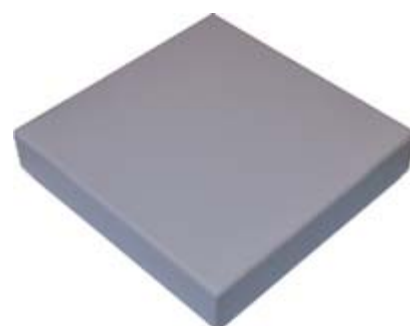

MONOLITE CERAMIC – this worktop is homogenous in the whole section, glazed with very high chemical resistance (except HF acid) and mechanical. Possibility to order flat or with marine edge.

ACID PROOF STAINLESS STEEL – worktop made of steel grade 1.4301 (AISI 304, DIN 1.4301). High mechanical and thermal resistance. Possibility to order worktop with marine edge.



Chemical resistance table of selected worktops - comparison test

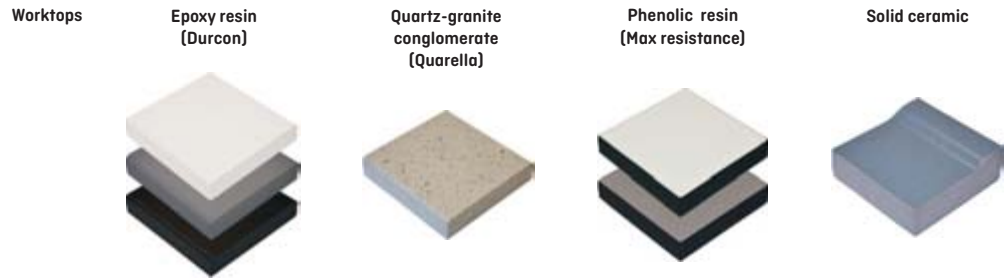

Chemical environment

1. Acetone
2. Acetonitrile
3. Alizarin
4. Ethyl alcohol 50%
5. Ethyl alcohol 95%
6. Ammonia 25%
7. Giemsa's Stain
8. Wright's Stain
9. Benzene
10. Acetic oxide
11. Aniline blue
12. Methylene blue
13. 2-Butane
14. Sodium chloride 10%
15. Ferric chloride
16. Potassium dichromate solution in sulfuric acid
17. Carbon tetrachloride
18. Congo red
19. 1,2-Dichloroethane
20. Dichloroethane
21. Potassium dichromate
22. N, N-Dimethylformamide
23. 1,4-Dioxane
24. Eosin
25. Diethyl ether
26. Phenol
27. Crystal violet
28. Methyl violet
29. Formaldehyde 37%
30. Carbonic fuchsin
31. Alkaline fuchsin
32. Furfural
33. Ethylene glycol
34. N-Hexane
35. Heptane
36. Izoctane
37. Crystalline iodine
38. Potassium iodide 10%
39. Carmine
40. Xylene
41. Nitric acid 10%

Chemical environment	Epoxy resin (Durcon)	Quartz-granite conglomerate (Quarella)	Phenolic resin (Max resistance)	Solid ceramic
1. Acetone				
2. Acetonitrile				
3. Alizarin		Blue		
4. Ethyl alcohol 50%				
5. Ethyl alcohol 95%				
6. Ammonia 25%				
7. Giemsa's Stain		Dark		
8. Wright's Stain		Dark		
9. Benzene				
10. Acetic oxide				
11. Aniline blue		Blue		
12. Methylene blue		Dark		
13. 2-Butane				
14. Sodium chloride 10%				
15. Ferric chloride			Blue	
16. Potassium dichromate solution in sulfuric acid	Dark	Blue		
17. Carbon tetrachloride				
18. Congo red				
19. 1,2-Dichloroethane		Blue		
20. Dichloroethane		Blue		
21. Potassium dichromate				
22. N, N-Dimethylformamide				
23. 1,4-Dioxane				
24. Eosin		Blue		
25. Diethyl ether				
26. Phenol				
27. Crystal violet		Dark	Dark	
28. Methyl violet		Dark	Dark	
29. Formaldehyde 37%				
30. Carbonic fuchsin		Blue	Dark	
31. Alkaline fuchsin		Dark	Dark	
32. Furfural	Blue	Dark		
33. Ethylene glycol				
34. N-Hexane				
35. Heptane				
36. Izoctane				
37. Crystalline iodine		Blue	Dark	
38. Potassium iodide 10%				
39. Carmine				
40. Xylene				
41. Nitric acid 10%				

The conditions of the test:

In the case of non-volatile substances, the reagent of app. 1/2 cm³ was placed on the tested sample of the material. Used in further tests chemicals were covered on the surface of the tested sample of the material with the glazed surface to slow down the evaporation process.

In the case of volatile reagents, soaked cotton was placed on the tested sample of the material and it was covered with the glass lid.

The test had ran for 1/6 hours; then the surface of the tested sample of the material was washed with water and the soap, then dried. The above table shows the test results.

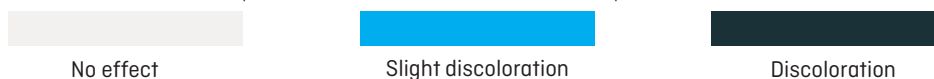

Chemical resistance table of selected worktops

Worktops

Epoxy resin
(Durcon)

Quartz-granite
conglomerate
(Quarella)

Phenolic resin
(Max resistance)

Solid ceramic

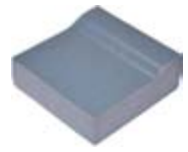
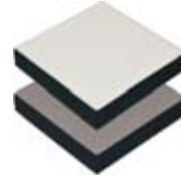

Chemical environment

- 42. Nitric acid 65%
- 43. Chromic acid 40%
- 44. Citric acid 10%
- 45. Hydrofluoric 48%
- 46. Phosphoric acid 85%
- 47. Acetic acid 5%
- 48. Crystal acetic acid
- 49. Oleic acid
- 50. Sulphuric acid 33%
- 51. Sulphuric acid 60%
- 52. Sulphuric acid 96%
- 53. Potassium permanganate
- 54. Kerosene
- 55. Butyl acetate
- 56. Ethyl acetate
- 57. Aniline oil
- 58. Cotton oil
- 59. Mineral oil
- 60. Transformer oil
- 61. Olive oil
- 62. Acridine orange
- 63. Sodium hypochlorite 5%
- 64. Soap solution 1%
- 65. Safranin
- 66. Copper(II) sulfate
- 67. Sudan III
- 68. Turpentine
- 69. Tetrahydrofuran
- 70. Trichloroethylene
- 71. Chromium oxide
- 72. Toluene
- 73. Sodium carbonate 2%
- 74. Sodium carbonate 20%
- 75. Distilled water
- 76. Boiled water [5 min.]
- 77. Hydrogen peroxide 3%
- 78. Hydrogen peroxide 20%
- 79. Ammonium hydroxide 28%
- 80. Sodium hydroxide 10%
- 81. Sodium hydroxide 50%
- 82. Malachite green

Chemical environment	Epoxy resin (Durcon)	Quartz-granite conglomerate (Quarella)	Phenolic resin (Max resistance)	Solid ceramic
42. Nitric acid 65%	Discoloration	Discoloration	Discoloration	No effect
43. Chromic acid 40%	Discoloration	Discoloration	Discoloration	No effect
44. Citric acid 10%	No effect	No effect	No effect	No effect
45. Hydrofluoric 48%	Discoloration	Discoloration	Discoloration	Discoloration
46. Phosphoric acid 85%	No effect	No effect	No effect	No effect
47. Acetic acid 5%	No effect	No effect	No effect	No effect
48. Crystal acetic acid	No effect	No effect	No effect	No effect
49. Oleic acid	No effect	No effect	No effect	No effect
50. Sulphuric acid 33%	No effect	No effect	No effect	No effect
51. Sulphuric acid 60%	No effect	No effect	No effect	No effect
52. Sulphuric acid 96%	Discoloration	Discoloration	No effect	No effect
53. Potassium permanganate	No effect	No effect	No effect	No effect
54. Kerosene	No effect	No effect	No effect	No effect
55. Butyl acetate	No effect	No effect	No effect	No effect
56. Ethyl acetate	No effect	No effect	No effect	No effect
57. Aniline oil	No effect	No effect	No effect	No effect
58. Cotton oil	No effect	No effect	No effect	No effect
59. Mineral oil	No effect	No effect	No effect	No effect
60. Transformer oil	No effect	No effect	No effect	No effect
61. Olive oil	No effect	No effect	No effect	No effect
62. Acridine orange	No effect	Discoloration	No effect	No effect
63. Sodium hypochlorite 5%	No effect	No effect	No effect	No effect
64. Soap solution 1%	No effect	No effect	No effect	No effect
65. Safranin	No effect	No effect	No effect	No effect
66. Copper(II) sulfate	No effect	No effect	No effect	No effect
67. Sudan III	No effect	No effect	No effect	No effect
68. Turpentine	No effect	No effect	No effect	No effect
69. Tetrahydrofuran	No effect	No effect	No effect	No effect
70. Trichloroethylene	No effect	No effect	No effect	No effect
71. Chromium oxide	No effect	No effect	No effect	No effect
72. Toluene	No effect	No effect	No effect	No effect
73. Sodium carbonate 2%	No effect	No effect	No effect	No effect
74. Sodium carbonate 20%	No effect	No effect	No effect	No effect
75. Distilled water	No effect	No effect	No effect	No effect
76. Boiled water [5 min.]	No effect	No effect	No effect	No effect
77. Hydrogen peroxide 3%	No effect	No effect	No effect	No effect
78. Hydrogen peroxide 20%	No effect	No effect	No effect	No effect
79. Ammonium hydroxide 28%	No effect	No effect	No effect	No effect
80. Sodium hydroxide 10%	No effect	No effect	No effect	No effect
81. Sodium hydroxide 50%	No effect	No effect	No effect	No effect
82. Malachite green	No effect	Discoloration	No effect	No effect

The conditions of the test:

In the case of non-volatile substances, the reagent of approx. 2cm³ was placed on the tested sample of the material. Used in further tests chemicals were covered on the surface of the tested sample of the material with the glazed surface to slow down the evaporation process.

In the case of volatile reagents, soaked cotton was placed on the tested sample of the material and it was covered with the glass lid.

The test had ran for 48 hours; then the surface of the tested sample of the material was washed with water and the soap, then dried. The above table shows the test results.

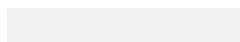

No effect

Slight discoloration

discoloration

Chemical resistance table of selected worktops

Chemical environment		temperature [°C]	1.4301	1.4404	1.4539
sea water		20	p.	p.	
dry chlorine		70			
chlorinated water	saturated	20		p.	p.
	½g/l	20	p.	p.	p.
	½mg/l	20			
ammonia		boiling			
sodium base	20%	50			
	20%	70			
	40%	70			
phosphoric acid	20%	boiling			
	40%	boiling			
	85%	95			
nitric acid	30%	boiling			
	50%	boiling			
	65%	80			
hydrochloric acid	65%	boiling			
	0,50%	20	p.	p.	p.
	0,50%	boiling			
sulphuric acid	1%	20	p.	p.	p.
	1%	70			
	5%	20			
	5%	boiling			
	10%	20			
	10%	boiling			
	20-90%	20-70			
citric acid	98%	20			
	25%	boiling			
lactic acid	50%	20			
	10%	10-70			
	50%	20-80			
formic acid	50%	boiling			
	5-10%	20			
	10%	80			
	50%	24-40			
acetic acid	50%	boiling			
	1%	boiling			
	20%	boiling			
	10%	boiling			
ammonium chloride	20%	boiling	s.p.	s.p.	s.p.
	43%	boiling	s.p.	s.p.	s.p.
calcium chloride	20%	20	p.	p.	p.
	20%	boiling	p.	s.p.	p.
sodium chloride	3%	20-60	p.	p.	p.

Based on the Øutokumpu Steel Professional Tool

corrosion rate [mm/year] resistance:

	total	< 0,½
	partial	0,½- ½
	none	> ½

s. - risk of stress corrosion
p. - risk of pitting corrosion

Fume hoods

General advantages

- construction entirely made of stainless steel
- conformity with PN EN 14175
- wide range configurations of worktop materials, working chamber, additional options



Smay Easy

- monitoring of the current flow with visual and acoustic alarms
- operation panel equipped with LEDs signaling diodes
- air flow measurement by the measuring module
- control of light and fan
- alarm indicating that sash window exceeds the maximum opening height
- group alarm signal with possibility to define its components



Smay SL-HLM

- adjustable air flow
- automatic sash window
- ability to set operation levels
- extended version of SMAY Easy controller



Q-Flow - air flow sensor

- controlling functions with alarm status indicated by visual and acoustic signals in case of decreased air flow
- alarm indicating that the sash window exceeds the maximum opening height
- display showing current airflow in m^3/h
- controlled and indicated alarm status
- recognition and optical signaling power failure
- continuous work even after power failure - build-in battery
- control of fume cupboard illumination



S_S variant

worktop – solid ceramics th. 35 - 37 mm,
with marine edges, in the worktop is placed ceramic
sink dims. 280 x 80 mm – under top mounted
internal chamber side walls made of steel covered
by chemically resistant epoxy paint



LC/CR_S variant

worktop – solid ceramics th. 35 - 37 mm,
with marine edges, in the worktop is placed ceramic
sink dims. 280 x 80 mm – under top mounted
internal chamber side walls made of 8mm Buchtal ceramic



LPP_S variant

worktop – solid ceramics th. 35 - 37 mm,
with marine edges, in the worktop is placed ceramic
sink dims. 280 x 80 mm – under top mounted
internal chamber side walls made of polypropylene

Standard equipment for fume hoods:

- 2 x 230V electrical sockets
- 2 x water taps with valves in the front panel
- ventilated underbench cabinet made of steel covered by chemically resistant epoxy paint, connected to the ventilation system of fume hood, designed for short-term storage of reagents, PP cuvette
- illumination of working chamber
- air-flow sensor

Optional equipment :

- additional media:
 - gas valves (technical gases and flammable gases)
 - electrical sockets
- explosion-proof equipment (illumination, electric sockets with plug adapters)
- glazed side walls 700x500 mm , made of tempered safety glass 4 mm
- grate on the back wall made of stainless steel
- elements of the fume hood made of stainless steel EN 1.4404 (construction, internal chamber, worktop, housing)
- possibility of placing safety cabinet under the fume hood instead of standard cabinet

DSM 1200



DSM 1500



DSM 1800



Parameter	DSM 1200	DSM 1500	DSM 1800	
overall dims [mm]	A width	1280	1580	1880
	B height	2325...2575	2325...2575	2325...2575
	C depth	940	940	940
working space dims [mm]	D width	1070	1370	1670
	E height	1400	1400	1400
	F depth	750	750	750
recommended airflow [m ³ /h]	450...650	650...850	850...1050	
maximum power consumption [kW]	3,5			
power supply	230V 50HZ			
exit air sub pipe diameter [mm]	160	200	200	
water supply	G 1/2"			
sewage connection diameter [mm]	50			
standard airflow sensor Q-Flow type	yes, conformity with standards PN-EN 14175-2			
standard equipment	2x electrical socket 230V (IP44) 2x cold water tap 1x sink			
electrical insulation class	class			
permissible work board load [kPa]	2	4	5	
warranty	24 months			
manufacturer	PØL-EKØ-APARATURA			

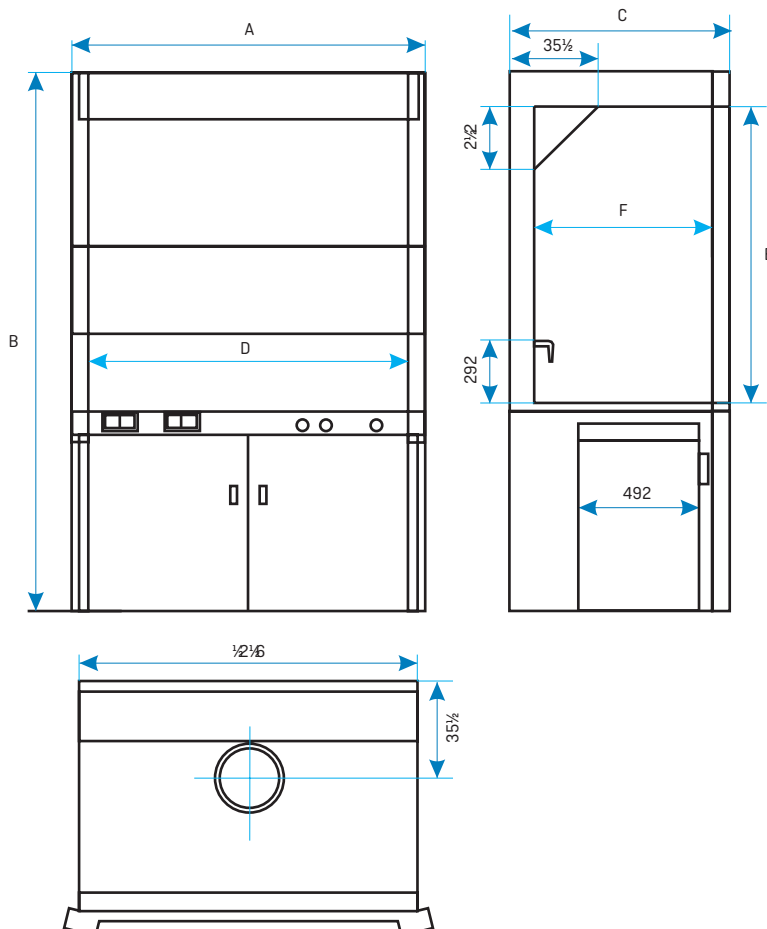

▀ Configurable fume hood according to your needs:



Tabletop fume hood



Fume hood designed for safety cabinet



Fume hood with polypropylene cupboard



Fume hood with reduced height, to be installed in rooms with lower ceilings.



Fume hood with glazing on both sides



WALK-IN fume hood



Every day we offer you our 25 years of experience! We offer a professional devices designed in accordance with Polish and European standards, manufactured by the most modern equipment available on world markets.



For years we have worked for people. We actively support the local association „Razem na szybko”, which organizes various actions for children, e-waste collection campaigns and many other events for local community.



We continuously improve our environmental friendliness. At POL-EKO-APARATURA we have implemented some renewable energy solutions, such as solar thermal and photovoltaic systems, heat pumps and electric cars for internal transport. We also segregate waste and use recyclable materials. Moreover, we are deeply involved in the "Zielone Światło" training course on pro-environment activities which is co-financed by the European Union.



POL-EKO-APARATURA is also a member of the Silesian Technopolis that actively supports local education, especially in the vocational field. We organize apprenticeships, various meetings for junior high school students and trainings for teachers. We have also co-financed an analytical laboratory in one of the Vocational Schools Complex in Wodzislaw Slaski

CONTROLTECNICA

C/ Artesanos 7, Boadilla del Monte - MADRID

Tlf: 91 728 0810

Fax: 91 7294454

lab@controltecnica.com



**DISTRIBUIDOR EXCLUSIVO EN ESPAÑA
DE LA MARCA:**

20¹⁶₁₇

POL-EKO-APARATURA

*manufacturer of controlled environment
equipment for laboratory analysis
and technological processes,
distributor in Poland of:
KNICK, THERMO SCIENTIFIC, WTW.*

POL-EKO-APARATURA sp.j
ul. Kokoszycka 172C
44 - 300 Wodzisław Śląski
POLAND
Tel: +48 32 453 91 70
Fax: +48 32 453 91 85
E-mail: export@pol-eko.com.pl
www.pol-eko.eu

Catalogue "Products of POL-EKO-APARATURA" version 11.1/2016.
In spite of taking necessary steps to avoid mistakes, we cannot
guarantee that the technical data in this catalogue is completely correct
POL-EKO-APARATURA company reserves the right to change some of
the technical parameters. All dimensions are given exact to ±5 %.